

# The Real Biofuel Cycles

*Tad W. Patzek*

*Department of Civil and Environmental Engineering  
425 Davis Hall, MC 1716  
University of California, Berkeley, CA 94720  
Email: patzek@patzek.berkeley.edu*

**Online Supporting Material for Science Letter, Vol. 312, p. 1747, 26 June, 2006**

July 11, 2006

## **Abstract**

This paper analyzes energy efficiency of the industrial corn-ethanol cycle and brackets energy efficiency of the switchgrass-cellulosic ethanol cycle. In particular, it critically evaluates the publications by Farrell *et al.* (2006a; 2006c) and Shapouri, Wang, et al. (Wang, 2001; Shapouri et al., 2002; Shapouri et al., 2003; Shapouri and McAloon, 2004). It is demonstrated that in a net-energy analysis of the industrial corn-ethanol cycle (Farrell et al., 2006a; Farrell et al., 2006c) did not (i) define the system boundaries, (ii) conserve mass, and (iii) conserve energy.

As already pointed out in (Patzek, 2004), most of the current First Law net-energy models of the industrial corn-ethanol cycle are based on nonphysical assumptions and should be discarded. The energy cost of producing and refining carbon fuels in real time, e.g., corn and ethanol, is high relative to that of fossil fuels deposited and concentrated over geological time. Proper mass and energy balances of corn fields and ethanol refineries that account for the photosynthetic energy, part of the environment restoration work, and the coproduct energy have been formulated. These balances show that energetically production of ethanol from corn is 2 – 4 times less favorable than production of gasoline from petroleum. From thermodynamics it also follows that ecological damage wrought by industrial biofuel production must be severe, see also (Patzek, 2004; Patzek and Pimentel, 2006). With maximum theoretical yield of ethanol and the DDGS coproduct energy credit, 3.9 gallons of ethanol displace on average the energy in 1 gallon of gasoline. Without the DDGS energy credit, this average number is 6.2 gallons of ethanol. Equivalent CO<sub>2</sub> emissions from corn ethanol are 50% higher than those from gasoline, and become 100% higher if methane emissions from cows fed with DDGS are accounted for.

The U.S. ethanol industry has consistently inflated its ethanol yields by counting 5 volume percent of # 14 gasoline denaturant (8% of energy content) as ethanol. Also, imports from Brazil and higher alcohols seem to have been counted as U.S. ethanol. A detailed analysis of 778 samples of 401 corn hybrids reveals that the highest possible yield of ethanol is  $2.64 \pm 0.05$  gal ethanol/per nominal wet bushel of corn. The commonly accepted USDA estimate of mean ethanol yield in the U.S., 2.682 gal EtOH/bu, is one standard deviation above the rigorous statistical estimate in this paper. From a mass balance of soil (Patzek, 2004), it follows that ethanol coproducts should be returned to the fields.

The energy efficiency of current cellulosic ethanol production is poorer than that of any other industrially produced liquid biofuel (Patzek and Pimentel, 2006).



## Contents

<b>1</b>	<b>Introduction</b>	<b>1</b>
<b>2</b>	<b>Corn Has No Energy</b>	<b>2</b>
2.1	Net energies of various fuels . . . . .	4
<b>3</b>	<b>Ethanol Yield is High</b>	<b>8</b>
3.1	Corn Characterization and Starch Content . . . . .	9
3.2	Starch Yield and Theoretical Ethanol Yield . . . . .	9
3.3	Comparison with Ethanol Industry Average . . . . .	14
3.4	Summary of Ethanol Yield Conclusions . . . . .	16
<b>4</b>	<b>Co-Products Receive Energy Credit</b>	<b>17</b>
<b>5</b>	<b>System Boundaries, Mass, and Energy Balance</b>	<b>19</b>
5.1	How to Analyze the Corn-Ethanol Cycle? . . . . .	21
5.2	The Mass Balances of Subsystems I-II . . . . .	21
5.2.1	Mass Balance of Corn Farming (Subsystem I) . . . . .	23
5.2.2	Overall Mass Balance of Soil (Subsystem I) . . . . .	23
5.2.3	Mass Balance of Corn Processing (Subsystem II) . . . . .	24
5.3	The Energy Balances of Subsystems I-II . . . . .	24
5.3.1	Energy Balance of Corn Farming (Subsystem I) . . . . .	24
5.3.2	Overall Energy Balance of Soil (Subsystem I) . . . . .	25
5.3.3	Overall Energy Efficiency of Corn Farming (Subsystem I + Environment) . . . . .	25
5.3.4	Energy Balance of Corn Processing (Subsystem II) . . . . .	26
5.4	What Is Wrong with Net-Energy Analysis? . . . . .	29
5.5	Coproduct Energy Credit Revisited . . . . .	30
<b>6</b>	<b>Equivalent CO<sub>2</sub> Emissions from the Corn-Ethanol Cycle</b>	<b>32</b>
<b>7</b>	<b>Ecology &amp; Macro-Economics of Corn Ethanol Production</b>	<b>33</b>
7.1	Ecological Consequences . . . . .	33
7.2	Economic Consequences for Midwest . . . . .	35
7.3	Economic Consequences for U.S. . . . .	36
<b>8</b>	<b>Cellulosic Ethanol</b>	<b>39</b>
<b>9</b>	<b>Summary and Conclusions</b>	<b>41</b>
<b>10</b>	<b>Acknowledgements</b>	<b>42</b>

## List of Tables

1	Energy efficiencies of fuel production processes . . . . .	7
2	Hybrid corn varieties in the 2005 Illinois database . . . . .	8
3	Overall Ethanol Yields Reported in Renewable Fuels Association's 2004 Ethanol Industry Outlook . . . . .	14
4	Corn kernel composition . . . . .	16

---

5	Average high and low heating values of fuels . . . . .	17
6	True cost of ethanol . . . . .	38

## List of Figures

1	Equivalence of ancient and contemporary sequestration of solar energy . . . . .	3
2	Ancient and new plants . . . . .	4
3	The carbon cycle . . . . .	5
4	Free energy (exergy) flow the ideal CO <sub>2</sub> -Glucose-EtOH cycle . . . . .	6
5	Fraction of motor gasoline replaceable with all U.S. corn . . . . .	7
6	Increase of passenger car mileage sufficient to replace all ethanol in the U.S. . . . .	8
7	Extractable starch vs. total starch . . . . .	10
8	Distribution of extractable starch . . . . .	11
9	Nominal losses in in #2 Yellow Corn . . . . .	11
10	Distribution of theoretical ethanol yields in kg/kg . . . . .	12
11	Distribution of grain moisture . . . . .	12
12	Distribution of theoretical ethanol yields in gal/bu . . . . .	14
13	Ethanol yields reported by the industry . . . . .	15
14	Fossil energy used in ethanol refineries . . . . .	19
15	Ratio of energy used to refine corn grain to ethanol and energy used to refine crude oil to diesel fuel . . . . .	20
16	DDGS from all U.S. corn as cow feed . . . . .	21
17	Mass and energy balance: system boundaries . . . . .	22
18	Overall energy efficiency of industrial corn-ethanol cycle . . . . .	30
19	Gallons of corn-ethanol needed to produce energy in 1 gallon of gasoline . . . . .	30
20	Equivalent CO <sub>2</sub> emissions by source . . . . .	32
21	Equivalent CO <sub>2</sub> emissions from corn ethanol and other fossil fuels . . . . .	34
22	Severe field soil erosion . . . . .	35
23	Surface area of the anoxic zone in GOM . . . . .	36
24	Normalized corn yield and price in Iowa . . . . .	37
25	E85 fuel is sold here . . . . .	39
26	Glucose decomposition paths . . . . .	47
27	Schematic of a dry grind corn ethanol plant . . . . .	48

*Nothing useless is, or low;  
Each thing in its place is best;  
And what seems but idle show  
Strengthens and supports the rest.*

The Builders by HENRY WADSWORTH LONGFELLOW

## 1 Introduction

This paper analyzes energy efficiency of the industrial corn-ethanol cycle and brackets energy efficiency of the switchgrass-cellulosic ethanol cycle. In particular, it critically reviews the Report by FARRELL *et al.*, *Ethanol Can Contribute to Energy and Environmental Goals*, Science, **311**, 506-508, 2006 (abbreviated here as Report). FARRELL *et al.* should be commended for attempting to bring together the different studies in the area of biofuel production. They acknowledge that environmental effects of large-scale biofuel production are poorly understood and need to be studied, and they indicate that large-scale use of ethanol will require lignocellulosic conversion.

The FARRELL *et al.* (2006a) Report is based on an Excel spreadsheet with cells containing numbers from three peer-reviewed papers (Patzek, 2004; Pimentel and Patzek, 2005; de Oliveira *et al.*, 2005) and four<sup>1</sup> gray-literature reports (Wang, 2001; Graboski, 2002; Shapouri *et al.*, 2002; Shapouri and McAloon, 2004). The authors cite the only relevant peer-reviewed paper by SHAPOURI *et al.* (2003) merely to rationalize their Footnote 6 that disposes of the calorific value of corn grain.

The Report's Supporting Online Material (abbreviated here as SOM) is a Users' Manual that explains the spreadsheet assumptions and contents. The authors then perform certain arithmetic operations on the numbers they have stored in the spreadsheet, from which they draw their conclusions.

There are several important peer-reviewed papers and books the Report does not mention, for example:

1. The outstanding book by Professor VACLAV SMIL *et al.* (1983) that contains the most complete physical model of industrial corn agriculture to date is not quoted.
2. The powerful and thorough book, *Fatal Harvest - The Tragedy of Industrial Agriculture* (Kimbrell, 2002), could inform the cellulosic ethanol enthusiasts, but is not mentioned. This book goes very well with another monograph by Professor SMIL, *Carbon - Nitrogen - Sulfur - Human Interferences in Grand Biospheric Cycles* (Smil, 1985).
3. The seminal Proceedings of the International Federation of Institutes for Advanced Study (Slessor, 1974; Slessor, 1975) that have provided guidelines for Parts II and III of (Patzek, 2004) are neither cited nor followed.
4. The great handbook of ecological case histories and the science tools used to address them, edited by Professors CHARLES HALL and JOHN DAY, JR. (Hall and Day, 1977), is neither cited nor followed. This book provides deep insights into the complex relationship between man and nature.

In order to arrive at their conclusions about corn and cellulosic ethanol, the authors chose the following path:

---

<sup>1</sup>The terse, 5-page report (Shapouri and McAloon, 2004) is incomplete and, e.g., corn ethanol yield must be inferred from (Shapouri *et al.*, 2002).

- 
- C1. **Corn Grain Has No Energy.** Calorific value of corn grain is omitted and not subtracted as a raw energy input to ethanol refineries.
  - C2. **Ethanol Yield Is High.** Average yield of corn ethanol is increased by more than possible.
  - C3. **Co-Products Receive Energy Credit.** Roughly 30 to 50% of the fossil energy used to distill ethanol is subtracted from the biorefinery energy balance<sup>2</sup>.
  - C4. **Results Are Consistent with Some Reports.** The final results are consistent with the following reports: (Wang et al., 1997; Wang, 2001), (Graboski, 2002), and (Shapouri et al., 2002; Shapouri and McAloon, 2004).
  - C5. **While Corn Ethanol May Not Be So Good, Cellulosic Ethanol Is.** Even if the average net fossil energy ratio *were* 1.2 for the corn ethanol-cycle<sup>3</sup>, the entire U.S. corn crop would replace only 2% of the energy in motor gasoline used in the U.S. Cellulosic ethanol, however, “could play a key role in meeting the nation’s energy and environmental goals.”

My thermodynamics paper was quoted because some of the numbers in the Report’s spreadsheet originated from it. The most important Part III of (Patzek, 2004) contains (i) the parameters classified in the spreadsheet as “NR” (for not reported), and (ii) a proper mass balance of soil and a free energy (Second Law) balance of corn-ethanol cycle. This Second Law balance: (1) Naturally accounts for the free energy of starch (C1), (2) highlights limitations of the USDA ethanol yield estimate (C2), (3) naturally separates starch and ethanol from corn grain leftovers and co-products (C3), and (4) calculates the ratio of the cumulative free energy consumed in ethanol production to mechanical work obtained from this ethanol to be up to 7:1, depending on the machine that transforms the chemical energy of ethanol into work (C4).

Here I will discuss at some length the scientific underpinnings of C1 – C5. I will try to make my reasoning accessible to general public.

## 2 Corn Has No Energy

The goal of this section is to remind the reader that crude oil has essentially the same relationship to gasoline as corn grain to corn ethanol. Both could be burned directly as fuel for cooking and heating<sup>4</sup>. Both are feedstocks in the production of an automotive liquid fuel (gasoline) and oxygenate<sup>5</sup> (ethanol), respectively.

Just as one subtracts the energy of petroleum input from the energy of refined fuel output (Sheehan et al., 1998) to estimate efficiency of a petroleum refinery, one must subtract the energy of corn starch input from the ethanol output (Patzek, 2004) of a biorefinery to estimate its efficiency. This was not done in the Report.

---

<sup>2</sup>Ethanol distillation is the single biggest expenditure of fossil energy in the corn-ethanol cycle, see Section 4.

<sup>3</sup>And it is *not*, even according to (Shapouri et al., 2003), see the two bottom lines in Table 6, and (Shapouri and McAloon, 2004), the bottom line of Table 3.

<sup>4</sup>Corn grain stoves have been used in the South and Southwest since 1969, when the stove was invented by CAROL BUCKNER of Arden, NC. The most famous demonstration of the heating power of corn was performed in the Oval Office, where a corn stove was installed during the administration of President Jimmy Carter. Apparently, corn is a carbon-based fuel just like petroleum. For more information, type into Google **corn grain stove**.

<sup>5</sup>It is well-known that the fundamental characteristic of an automotive fuel governing the distance driven is the fuel’s heating value (Brinkman et al., 1975; Berger, 1984), provided that the stoichiometric air/fuel ratio is used. Ethanol molecule has  $16/46 = 0.35$  of oxygen, which does not contribute to its heating value. Therefore, its heating value (low or high, see Table 5 below) is about 65% of the heating value of gasoline, and ethanol should be classified as oxygenate.

As shown in **Figure 1**, crude oil, coal, natural gas, – and corn grain – are the results of chemical transformations of carbon dioxide, water, and nutrients in ancient and contemporary plants, respectively, see **Figure 2**. All of these chemical processes are powered by the sun<sup>6</sup>. The processes of plant growth, burial, and transformation – and corn farming – are two *cycles*, see **Figure 3**, that occur on vastly different time scales. The various predecessors of anthracite, crude oil, and natural gas (peat moss, lignite, brown coal, oil-shale, etc.), are different stages of concentration of the chemical energy stored in plants. Similarly, corn grain is a one-year concentrate of the CO<sub>2</sub>, H<sub>2</sub>O, N, P, K, Ca, S, Mg, Fe, Cl, Na, Si, Zn, B, Cu, Mn, Se, etc., captured by living plants fueled by the sun.

As discussed by, e.g., Professors NICHOLAS GEORGESCU-ROEGEN (1971), EUGENE ODUM (1998), DAVID PIMENTEL (1996), PATZEK (2004), and many others, solar energy is *not* the limiting factor in plant growth; the appropriate soil conditions and water availability are. If it were otherwise, the sunny Sahara desert would be the best place to grow corn<sup>7</sup>.

**Remark 1** Corn grain is as much a carbon-based fuel as petroleum, wood, or coal are. It is used as feedstock to produce ethanol as much as petroleum is used to produce gasoline or diesel fuel. □

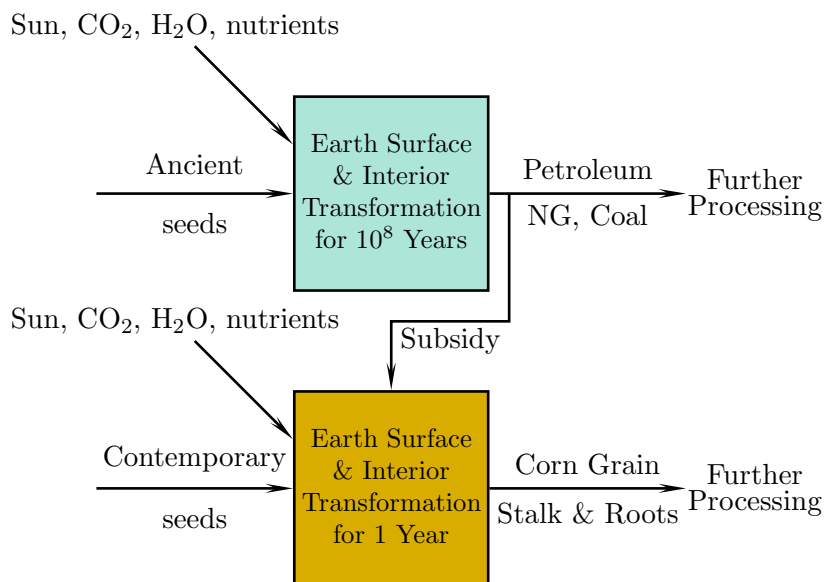

Figure 1: To accelerate the contemporary plant growth, a significant subsidy from ancient plants is used. After being transformed for  $\mathcal{O}(1 - 1000)$  years on the earth surface and  $\mathcal{O}(10^8)$  years in the earth interior (1-10 km BGS), some ancient plant seeds became crude oil, natural gas, or coal. After transformation on the earth surface and shallow interior (0-1 m BGS) for  $\mathcal{O}(10^0)$  years most corn seeds become corn grain, stalk, and roots. Despite the schematic’s anthropomorphic slant in depicting generation of crude oil and corn as *linear* processes, both these processes belong to natural cycles that occur on two vastly different time scales, see (Smil, 1985), (Patzek, 2004), Part II, and (Patzek and Pimentel, 2006).

<sup>6</sup>In the generation of ancient fossil fuels, heat from the earth’s natural radioactivity and bacterial activity should also be factored in.

<sup>7</sup>The exact words of Professor GEORGESCU-ROEGEN (1971), p. 302, were: “Otherwise, the paradise for all living creatures would be in the sunny Sahara.”



Figure 2: **Left:** Exceedingly few, see (Patzek & Pimentel, 2006), ancient plants, like this fossilized *Woodwardia virginica* foliage, ever become coal, crude oil, or natural gas. **Right:** Many corn seeds become plants. Image sources: [www.botany.org/PlantImages/](http://www.botany.org/PlantImages/) (left), W. SUSZYŃSKI (right).

If one observes that the corn  $\rightarrow$  ethanol process is a cycle, as shown in **Figures 3** and **4**, and one performs a proper (free) energy balance of that cycle, it becomes immediately obvious (Patzek, 2004) that

1. The starch energy *is* a part of energy accounting, and
2. The non-starch part of corn grain (future dry distiller's grain and solubles (DDGS) or similar) *is not* a part of the glucose-beer distillation process.

Sometimes, the corn-ethanol cycle is imagined as the flow of only fossil energy into corn fields and corn ethanol. This view is inaccurate. Without good soil and a plethora of nutrients in the soil's water and organic matter, fossil fuels can do nothing. Imagine plowing and pouring fertilizers onto sterile desert sand, planting seeds, and waiting for the sun to do its share free of charge (Patzek et al., 2005).

By focusing only on fossil energy, the incomplete net-energy balances of corn-ethanol cycle lead to erroneous conclusions and should be discarded. A complete First Law energy balance is formulated instead in Section 5 to fully describe the corn-ethanol cycle.

**Remark 2** Demonstrating incompleteness of the First Law energy balances of corn-ethanol cycle, and proposing a more complete Second Law free energy balance was the essence of my thermodynamics paper, see Parts II – IV in (Patzek, 2004). The authors' Excel spreadsheet impugns (Patzek, 2004) for not reporting most primary energy inputs and Biological Oxygen Demand (BOD) cleanup costs in a biorefinery. These inputs were defined *and* used in Part III of (Patzek, 2004) in a proper, Second Law energy balance of the corn-ethanol cycle.  $\square$

## 2.1 Net energies of various fuels

Only to illustrate how the First Law energy balances might be used, I will now consistently rank production of motor gasoline (or diesel fuel), coal, and corn ethanol. A detailed life-cycle analysis



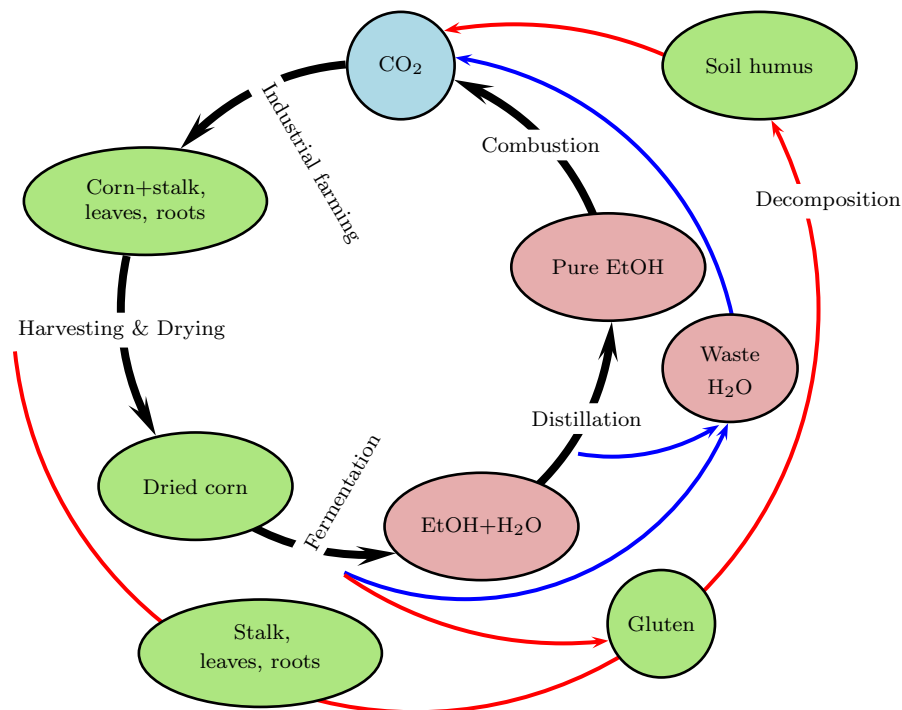

Figure 3: The internal carbon cycle in the industrial corn-ethanol cycle can be closed only by recycling most of the corn-plant and corn-grain components. Adapted from Figure 6 in BERTHIAUME *et al.* (2001) and reproduced from (Patzek, 2004).

of diesel fuel produced in the U.S. from a mixture of domestic and foreign crude oil was performed in (Sheehan *et al.*, 1998), and I will accept it as is<sup>8</sup>. Other analyses (Spreng, 1988; Szargut *et al.*, 1988) of energy spent on producing gasoline are more optimistic, but the rather small differences do not influence my argument. The coal life-cycle analysis was performed in a class I taught at Berkeley in 2004, and I will use its results. I will also use the different energy balances of the industrial U.S. corn-ethanol cycle published in Part I of (Patzek, 2004), knowing fully well that the ethanol yields used in (Wang *et al.*, 1997; Wang, 2001) and (Shapouri *et al.*, 2002; Shapouri and McAloon, 2004) are too high. All energy balances are per unit energy in the input (crude oil, raw coal, and corn grain) that produces the desired output (gasoline, diesel fuel, pulverized coal dust, and ethanol).

**Remark 3** Since there can be no finished fuel *output* without a raw fuel *input*, all energy balances should be done per unit of the input energy. In ethanol literature (see C4), energy balances are commonly done per unit of energy output. Once the raw fuel input is ignored, as in the Report, there is no other choice, see equations (S-1) – (S-3), and (S-7) in SOM.  $\square$

For example, 0.833 MJ in diesel fuel (slightly less in gasoline) will be produced per 1 MJ in crude oil starting from an oil reservoir in the U.S. or overseas (Sheehan *et al.*, 1998), p. 11. Coal dust from pulverized coal, ready to be burned in a remote power station, will have 0.984 MJ per 1

<sup>8</sup>Consistently with my analysis, I will use SHEEHAN *et al.*'s (1998) estimate of primary energy spent on crude oil production (domestic and foreign), transport, refining, and finished diesel fuel transport. This estimate is listed in Table 3, page 11. The Fossil Energy Ratio = 1 MJ Fuel Energy/1.1995 MJ of Fossil (Primary) Energy Input = 0.8337. The Fossil Energy ratio of crude oil refining is 0.065. Figure 2, on page 13, rescales the components of Table 1 to MJ/MJ of Fuel. In the rescaled units, the energy spent on refining is 0.12 of the energy in diesel fuel.

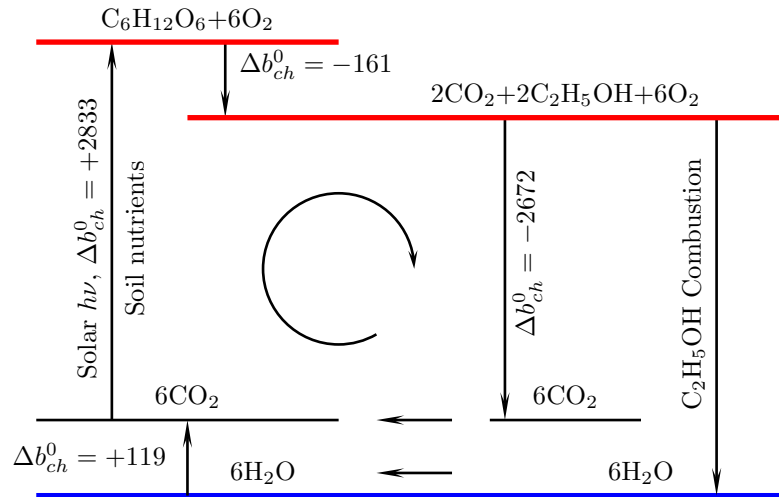

Figure 4: Flow of photosynthetic and chemical free energy (exergy  $b$ ) in the ideal, fossil-fuel-free,  $\text{CO}_2$ -Glucose-EtOH cycle. The units are MJ/kmol. Please remember that the water-dissolved nutrients in good soil control plant growth and solar energy sequestration as biomass. Only some 0.3% of the vast solar energy input is used annually to produce an excellent corn crop, see, e.g., (Good and Bell, 1980; Lemon, 1960; Musgrave and Moss, 1961; Patzek, 2004). Adapted from (Patzek, 2004).

MJ in coal from a near-surface deposit in Western United States, and 0.970 MJ per 1 MJ in coal from a coal seam in Eastern United States. The output/input energy ratio (energy efficiency) can be defined as

$$\eta_{\text{fuel}} = \frac{\text{Fuel Output/Unit Feedstock Energy}}{1 + \sum \text{Process Energies/Unit Feedstock Energy}} \quad (1)$$

The calculations based on the data in (Patzek, 2004), Part I, are listed in **Table 1** and the conclusion is immediate<sup>9</sup>.

**Remark 4** An industrial corn field is a contemporary carbon fuel reservoir that is filled with biomass in real time by the joint action of water, soil nutrients, fossil energy subsidies, and photosynthetic energy. The calculations of the process energy spent to produce a fuel (diesel, gasoline, or coal) or an oxygenate (ethanol) show that production of corn-ethanol is  $\sim 3 - 4$  times *less* efficient relative to gasoline or pulverized coal. The primary sources of the process energy are the main feedstocks in their original states (crude oil in a reservoir, coal in a deposit, and corn seeds).  $\square$

This 3- or 4-fold difference in the energy transfer efficiency is caused by the rate of the transfer, and the lack of concentration and transformation of chemical energy in biomass. In other words, given  $10^8$  years, crude oil or coal became almost pure automotive or power station fuels, while corn grain created in 100 days is far from being pure ethanol.

In addition to the low energy efficiency, ethanol from corn delivers only  $\sim 0.2 \text{ W/m}^2$  of the field (Patzek and Pimentel, 2006). Therefore, the quantity of ethanol produced by converting even *all* corn in the U.S. will be minuscule relative to the current consumption of motor gasoline or diesel fuel, see **Figure 5**. In 2012, 7.5 billion gallons of ethanol will be produced in the U.S., as

<sup>9</sup>First Law energy calculations in Part I of (Patzek, 2004) did *not* account for photosynthetic energy and for the environment restoration work; both were included in Part III of (Patzek, 2004) in the subsequent Second Law analysis, and will be included here in Section 5 in First Law calculations. As it turns out, the energy efficiencies calculated in Table 1 will not change much.

mandated by the 2005 Energy Bill. At best, the magnitude of this contribution to the total motor gasoline consumption will be the same as that of proper inflation of tires in passenger cars (with no improvement in driving habits), see **Figure 6**.

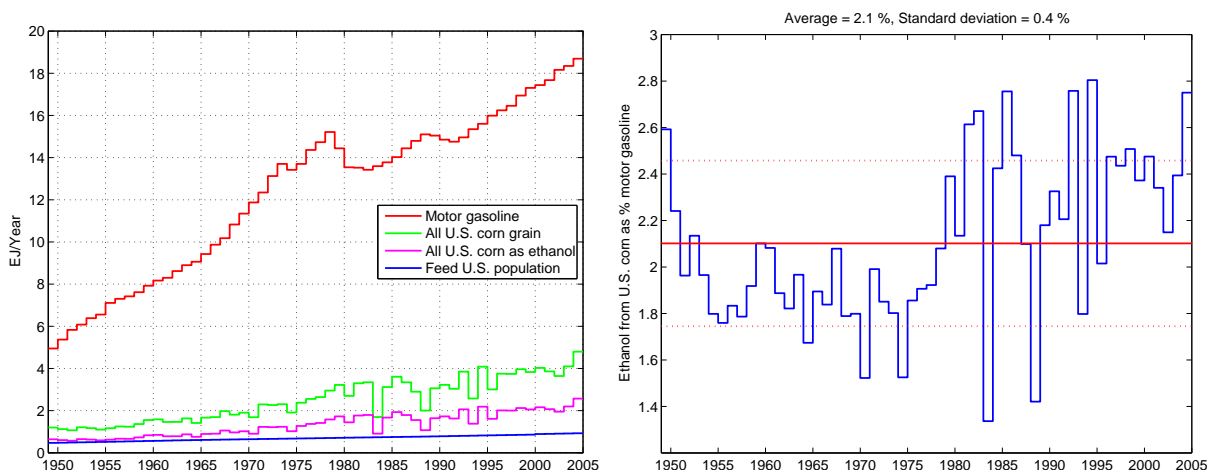

Figure 5: **Left:** Energy-equivalent comparison of motor gasoline consumed in the U.S. between 1949 and 2004, and energy in all U.S. corn grain and ethanol obtained from this grain. The constant ethanol yield is equal to the industry average of 2.6 gal/bu discounted by 5%. **Right:** The net fraction of motor gasoline that could be replaced with ethanol from all U.S. corn grain if the average fossil energy ratio of the corn-ethanol cycle *were* 1.2, but it never *is*, see (Shapouri *et al.*, 2003), Table 6, and Section 5. Data sources: EIA and USDA NASS.

The latter observation leads to the most important practical remark of this paper.

**Remark 5** Notwithstanding the conclusions in (Farrell *et al.*, 2006a), the United States has already squandered a lot of time, money, and natural resources (top soil, water, fossil resources, steel, concrete, etc.) on pursuing the mirage of an energy supply scheme that *cannot* replace fossil fuels in aggregate (natural gas + coal + crude oil). Instead, we should decrease consumption of these fossil fuels, increase the efficiency of our economy, while producing some biofuels for local consumption.  $\square$

Table 1: Fuel production efficiencies defined in Eq. (1)

Source	$\eta_{\text{fuel}}$	$\frac{\eta_{\text{coal}}}{\eta_{\text{fuel}}}$
Pimentel, 2003 <sup>a</sup>	0.262	3.8
Patzek, 2004 <sup>a</sup>	0.245	4.0
Shapouri <i>et al.</i> , 2002 <sup>a</sup>	0.307	3.2
Wang <i>et al.</i> , 1997 <sup>a</sup>	0.310	3.2
Berthiaume <i>et al.</i> , 2001 <sup>a</sup>	0.275	3.6
Diesel fuel <sup>b</sup> , Sheehan <i>et al.</i> , 1998	0.833	1.2
Western coal, Patzek, 2004	0.984	1.0
Eastern coal, Patzek, 2004	0.970	1.0

<sup>a</sup> As listed in Part I of (Patzek, 2004)

<sup>b</sup> Or motor gasoline

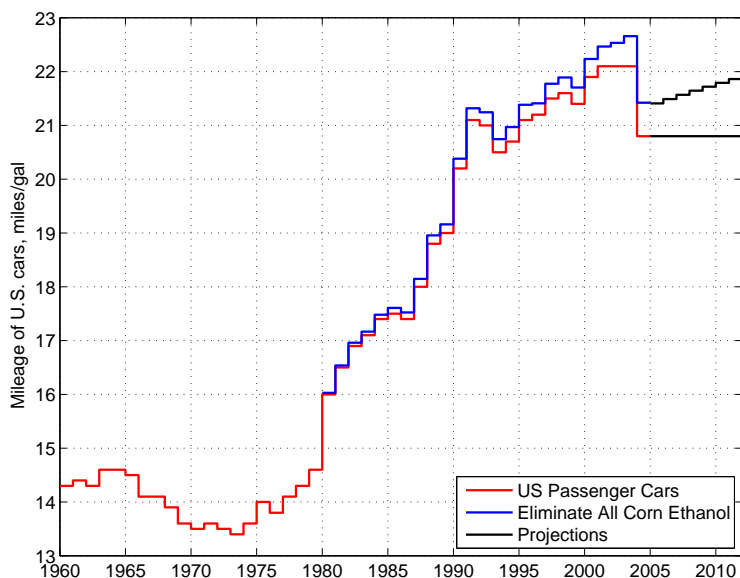

Figure 6: Sources: DOE EIA, U.S. Bureau of Transportation Statistics, EPA. The red curve is the historical mileage of U.S. passenger car fleet, excluding SUVs, light trucks and vans. Note the dramatic decrease from 21.2 miles per gallon (mpg) in 2001–2003 to 20.8 mpg in 2004. The blue curve is the calculated increase of mileage of the U.S. passenger car fleet sufficient to eliminate the use of all ethanol *with* the Reid Vapor Pressure (RVP) waver. For example, the energy in 7.5 billion gallons of ethanol could be eliminated by an increase of car mileage by 1 mile per gallon, or going back to the average passenger car mileage in the year 2000. Thus the entire effect of corn ethanol in 2012 will be less than the effect of inflating properly the U.S. passenger car tires. Note that I have not subtracted here the high energy cost of producing ethanol.

Table 2: Hybrid corn varieties in the 2005 Illinois database

Region or Plant Management	Yield&Moisture Location	Starch Content <sup>a</sup> / Extractable Starch	# Samples/ Varieties
West Central	Monmouth, Perry, New Berlin	Urbana	143
South	Brownstown, Belleville Carbondale	Belleville	108
North	Mt Morris, DeKalb, Erie	DeKalb	154
East	Dwight, Goodfield, Urbana	Urbana	169
CFC <sup>b</sup> + RRC <sup>c</sup>	Urbana	Urbana	36+40
CFC + RRC	DeKalb	DeKalb	36+19
RRC	Belleville	Belleville	20
CFC + RRC	Monmouth	Monmouth	34+19

<sup>a</sup> See Footnote 10

<sup>b</sup> Corn following corn

<sup>c</sup> Roundup-resistant corn

### 3 Ethanol Yield is High

The purpose of this section is to quantify the mean extractable starch in hybrid corn, and the mean stoichiometric (highest possible) yield of ethanol from this starch. My statistical calculations are

based on the extensive database published annually for hybrid corn varieties in Illinois (Joos, 2005). I then compare my results with the ethanol industry's data and the USDA estimate of 2.682 gal EtOH/wet bushel (Shapouri et al., 2002).

### 3.1 Corn Characterization and Starch Content

Based on the results of the Illinois State Variety Test in 2005 (Joos, 2005), the mean starch content of 778 samples of 401 commercial varieties of hybrid corn, see **Table 2**, was 71%, and the mean extractable starch<sup>10</sup> was 66%, the same as in (White and Johnson, 2003) and (Patzek, 2004), see also **Figure 7**. As shown in **Figure 8**, extractable starch in Illinois follows almost perfectly the following normal distribution:

$$ES = \frac{1}{\sqrt{2\pi} \times 1.13} \exp \left[ -\frac{(\text{extractable starch} - 66.18)^2}{2 \times 1.13} \right] / 100 \quad (2)$$

A measure of most interest to me is *fermentable starch*. Extractable starch measures what is available from a *wet milling process*. However, almost all new ethanol is produced in a dry grind process and more than extractable starch could be fermentable.

**Remark 6** One could argue<sup>11</sup> that the *total*, not extractable, starch should be used to estimate the ultimate yield of corn ethanol in dry grind plants<sup>12</sup>. Also, the difference between the two starch contents may depend on the measurement method. I will try to investigate this complex issue later<sup>13</sup>. □

### 3.2 Starch Yield and Theoretical Ethanol Yield

Now we are ready to obtain estimates of ethanol yield from the hybrid corn varieties tested in Illinois. To do so, Monte Carlo simulations have been run using the normal distribution in Eq. (2). To obtain the net starch yield, the nominal grain losses (White and Johnson, 2003) caused by crushed grain, dirt, pebbles, etc., have been estimated as

$$\text{Loss} = \frac{1}{\sqrt{2\pi} \times 0.7} \exp \left[ -\frac{(\text{Percent loss} - 3)^2}{2 \times 0.7} \right] / 100 \quad (3)$$

A single realization of the normal distribution (3) is shown in **Figure 9**.

---

<sup>10</sup>Measuring extractable starch is a tricky problem (Eckhoff et al., 1996; Paulsen et al., 2003). Corn starch measurements in the Illinois data set are performed using the Corn Refiners Association (CRA) method. The extractable starch is from a 100-g test by Dr. ECKHOFF (Eckhoff et al., 1996). Dr. PAULSEN (Paulsen et al., 2003) uses the 100-g extractable starch test as a reference method for the NIR prediction of extractable starch. Sources: Drs. DARIN JOOS and MARVIN PAULSEN, 360-B Ag Engr. Sciences Bldg, 1304 W. Pennsylvania Ave, Urbana, IL 61801, 217-333-7926. Private communication, Feb. 8, 2006.

<sup>11</sup>Apparently, FARRELL et al. did not read this remark when they formulated their Response in Science (2006b): "...Nonetheless, much of his analysis (*i.e.*, *this paper*, *TWP*) appears to be rigorous in detail but erroneous overall. For instance, extractable starch only applies to wet milling, which presently produces approximately 30% of U.S. ethanol. Almost all new ethanol plants are dry mills, for which total fermentable starch is a better measure of ethanol yield, and that yield at least 5% more ethanol per unit mass of corn than wet milling."

<sup>12</sup>Dr. MARVIN PAUL SCOTT, USDA-ARS, Private communication, Feb. 1, 2006.

<sup>13</sup>Dr. DAVID ANDRESS of EIA has observed that the corn starch analysis in this paper considers all corn samples, but ethanol plant operators attempt to purchase high extractable starch corn. This can be accomplished by segregation or the use of inexpensive testing procedures. The difference in extractable starch is on the order of several percent. I will investigate his observation if I pursue this subject further. Source: Private communication, Feb. 22, 2006.

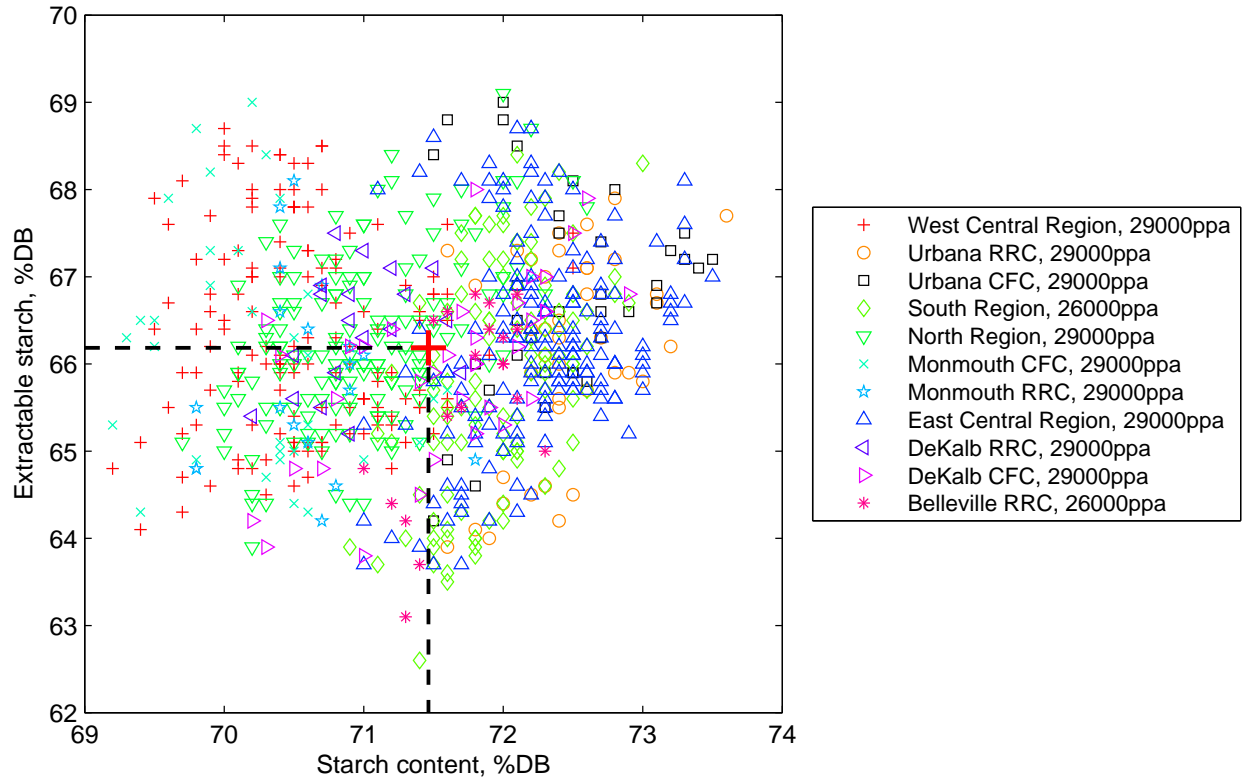

Figure 7: Source: The 2005 Illinois State Variety Test (<http://vt.cropsci.uiuc.edu/corn.html>), accessed 12/01/05. Some 401 commercial hybrids were grown in four regions of Illinois (not all hybrids were grown in all regions). The starch content was predicted by NIR. The number of samples from 12 locations is 778. The mean starch content is  $71.46 \pm 0.92\%$ . The mean extractable starch is  $66.18 \pm 1.13\%$ . The acronyms are ppa = plants per acre, CFC = corn following corn, RRC = Roundup-resistant corn.

To obtain a distribution of the net yield of extractable starch, the individual random variables (2) and (3) were treated as statistically independent and 2500 realizations were used.

Given the random extractable starch (ES) in Eq. (2) and the corn losses in Eq. (3), the maximum theoretical ethanol yield can be calculated as

$$\text{Theoretical EtOH Yield} = (1 - \text{Loss}) \times \text{ES} \times \frac{180}{162} \times 0.51 \frac{\text{kg EtOH}}{\text{kg dry corn}} \quad (4)$$

The Monte Carlo simulation results are shown in **Figure 10**. The mean stoichiometric ethanol yield is 0.364 kg EtOH/kg dry corn, and the standard deviation is 0.007. Note that the current statistical estimate of the theoretical yield of ethanol from absolutely dry corn grain is somewhat lower than the 0.374 kg EtOH/kg dry corn in (Patzek, 2004). According to **Remark 6**, the theoretical ethanol yield in dry grind plants may be higher.

The U.S. ethanol industry uses a confusing and imprecise system of units and it customarily exaggerates ethanol yields. For example, ethanol is measured by volume of unknown composition and corn grain is measured in bushels with unknown moisture content.

**Remark 7** One gallon of ethanol reported by the industry contains 5% by volume of #14 gasoline denaturant, which is *not* ethanol, and, therefore, all ethanol yields are overestimated by at least

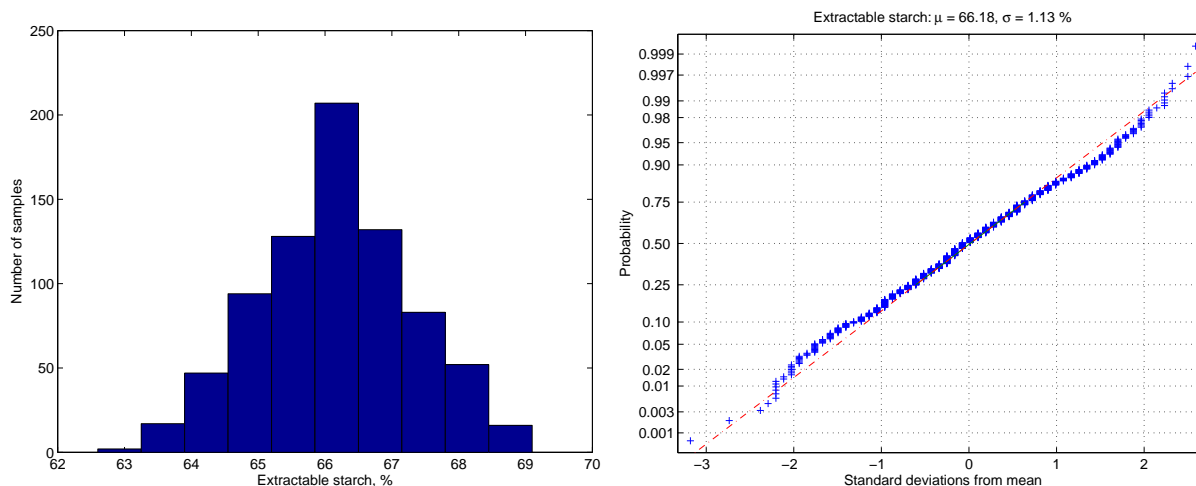

Figure 8: The histogram and normal distribution plot of extractable starch in the 778 samples shown in Figure 7. Extractable starch is almost perfectly normally distributed.

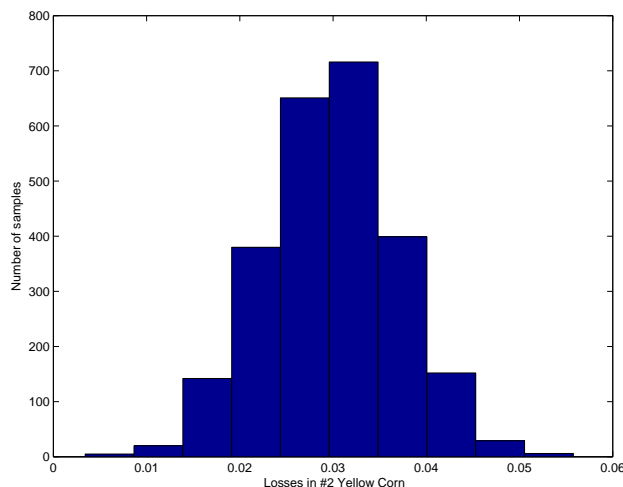

Figure 9: The histogram of nominal losses in #2 Yellow Corn (White and Johnson, 2003) . The normal distribution mean is 3% and the standard deviation is 0.7%.

5%. □

From Definition 1 in (Patzek, 2004) it follows that the *nominal* bushel of corn is 56 pounds of corn grain with 15% of moisture by mass. Depending on the source and age of corn grain, its moisture content will not be uniformly 15%. The moisture content in the Illinois hybrid corn varieties harvested in 2005 is shown in **Figure 11**. It follows a log-normal distribution

$$M = \frac{1}{\sqrt{2\pi} \times 1.18} \exp \left[ -\frac{(\text{logarithm of moisture content} - 18.43)^2}{2 \times 1.18} \right] / 100 \quad (5)$$

with the mean of 18.4%, see **Figure 11**.

**Remark 8** Moisture content in corn grain influences ethanol yield. In the case illustrated in Figure 11, the theoretical ethanol yield will be lower by  $\sim 3\%$  on the average. □

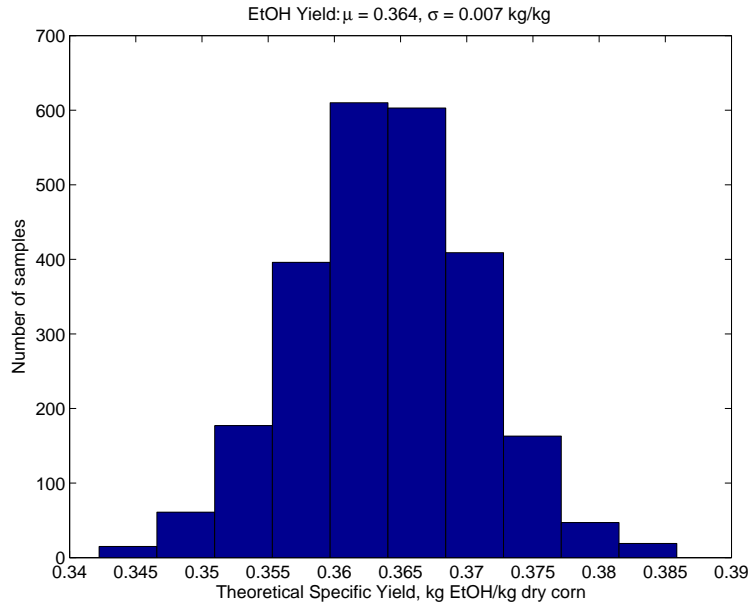

Figure 10: The theoretical stoichiometric yield of ethanol given the extractable starch content in Figure 7 and the nominal grain losses in Figure 9. The mean theoretical yield is 0.364 kg EtOH/kg of dry grain and the standard deviation is 0.007 kg/kg.

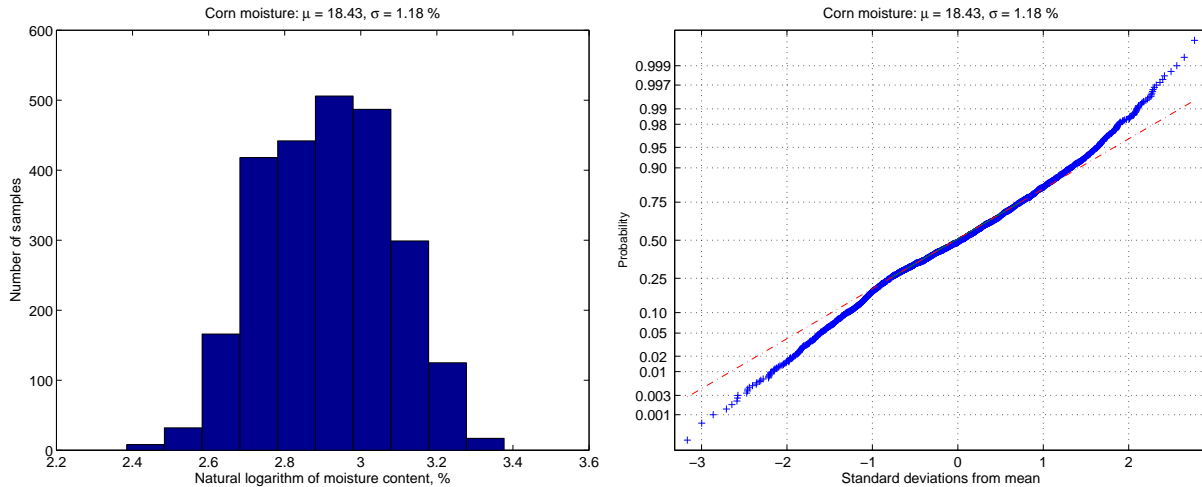

Figure 11: The histogram and normal distribution plot of the logarithm of moisture content in the 2500 corn samples in the 2005 Illinois State Variety Test. The moisture content is almost log-normally distributed. The mean of 18.4% is significantly higher than the nominal 15% used in most standard calculations of corn ethanol yields.

The rigorous Eq. (4) is approximately converted to gallons of EtOH per nominal 15%-wet bushel by multiplying it by

$$\frac{56 \times 0.454 \times 0.85}{0.787 \times 3.785} \quad (6)$$

The results are shown in **Figure 12**. The mean stoichiometric ethanol yield is 2.64 gal EtOH/nominal wet bushel, and the standard deviation is 0.05 gal/bu.



The mean theoretically extractable starch in Figure 7 is 92.7% of the mean starch content in corn grain. This amount can be extracted only in the best refineries. Some of this starch and other components of the fermentation mash, corn oil, and germ are converted to other products (Dawes and Large, 1982), such as methyl, amyl, iso-amyl, isobutyl, n-propyl, 1,2,3-propanetriol (glycerol), and higher alcohols; ethers; acetic aldehyde and acid, other organic acids, etc. Some possible reaction paths are shown in **Figure 26**. The main byproducts are isopropyl and isobutyl alcohols. Other byproducts are formed in the deamination and decarboxylation reactions of amino acids in the mash, etc. In average refineries or poor fermentation batches, ethanol yield decreases by up to 10%. Any pentoses (5-carbon sugars) are also converted to furfural (furan-2-carbaldehyde), one of the best organic solvents. Furfural in an impure ethanol mixture will gradually dissolve almost any rubber or elastomeric seals or ducts in storage systems and car fuel systems.

Fermentation to ethanol is carried out by yeast. Fermentation to butanol (and decomposition to methane) is carried out by anaerobic bacteria. The outcome is critically dependent on the purity of either microorganism culture.

**Remark 9** Corn mash must be thoroughly sterilized prior to addition of the appropriate microorganism culture to start the desired conversion. Quality of sterilization is even more important for cellulosic ethanol processes, see Section 8. □

With time, a yeast fermentation process will be dominated by the most competitive bacteria. The longer the duration of the batch fermentation process is, the more equilibrium shifts towards higher alcohols, aldehydes, acids, or methane. Average duration of batch ethanol fermentation is 40-45 hours, but some factories use up to 72-hour batches to achieve higher ethanol yields, while running substantial risk of having bad batches that must be recycled<sup>14</sup>.

Direct evidence of competing reaction pathways in a dry grind ethanol plant comes from the chemical analysis of gas emissions from plant equipment<sup>15</sup>. For example, in the Gopher Ethanol Plant, St. Paul, MN, (Anonymous, 2003), high-to-moderate concentrations of the following volatile organic substances (VOCs) were found: Methane, methanol, ethanol, toluene, ethylbenzene, acetone, formaldehyde, acetaldehyde, acrolein, benzene, styrene, 1,3-butadiene, 1,3-pentadiene, 1-2-propadiene, 1-4-pentadiene, 1-decene, 1-dodecene, 1-heptene, 1-hexene, 1-methyl-2-cyclopropene, 1-nonene, 1-octene, 1-undecene, 2-butanone, 2-butenal, 2-furancarboxaldehyde, 2-heptenal, 2-methyl-1-pentene, 2-methyl-2-propenal, 2-methyl-butanal, 2-methyl-furan, 2-methylpropenal, 2-pentyl-furan, 2-propen-1-ol, 2-propenal, 3-methyl-butanal, 6-heptenoic acid, benzaldehyde, furan, hexanal, nitro-methane, etc. Also liquid lactic acid, acetic acid, 2-furancarboxaldehyde, etc., were detected.

---

<sup>14</sup>This is usually done by dumping bad mash onto the surrounding land. As reported by PERRY BEEMAN of *The Des Moines Register*, Sept. 11, 2005: "Iowa plants - which produce a third of the nation's ethanol supply - have sent syrup, batches of bad ethanol and sewage into streams. As the pollutants decomposed, the waters lost oxygen, threatening fish. ... Gieselman said inspectors discovered plant construction contractors were telling farmers the plants wouldn't discharge into waterways. "They do," Gieselman said. The state has forced many of the plants to install holding ponds so the pollutants decompose or settle out before the water flows into streams used by fishing enthusiasts, canoeists and thirsty livestock."

<sup>15</sup>Under current rules, plants are classified as "major sources" of pollution and forced to go through the more-cumbersome approval process if they emit in excess of 100 tons per year of a particular pollutant, such as nitrogen oxide, dust, or volatile organic compounds such as formaldehyde. The EPA this week proposed to boost that cap to 250 tons per year. The agency said the higher cap is justified because that is the limit for grain-processing facilities that make alcohol along with a range of food products. The typical ethanol plant in Iowa puts out 300 to 350 total tons of pollutants per year, including nitrogen oxide, sulfur dioxide and various volatile organic compounds, according to the Iowa Department of Natural Resources. Source: *The Des Moines Register*, Des Moines, IA, March 6, 2006.

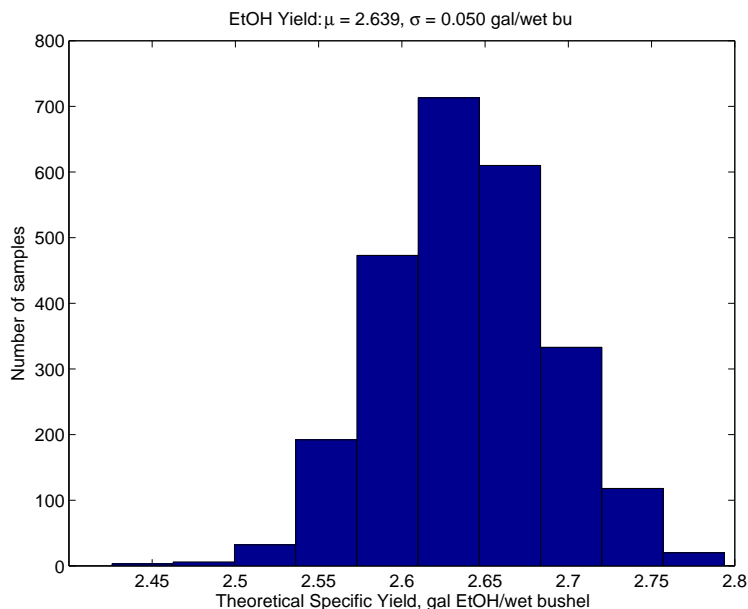

Figure 12: The theoretical stoichiometric yield of ethanol given the extractable starch content in Figure 7 and the nominal grain losses in Figure 9. The mean is 2.64 gal/wet bushel and the standard deviation is 0.05 gal/wet/bushel.

Table 3: Overall Ethanol Yields Reported in Renewable Fuels Association's 2004 Ethanol Industry Outlook

Year	Billion Gallons	Million Bushels
2000	1.63	627
2001	1.77	681
2002	2.13	819
2003	2.81	1077
2004	3.41	1220

### 3.3 Comparison with Ethanol Industry Average

The detailed calculation of theoretical ethanol yield in Illinois in 2005 is now compared with the annual ethanol industry's averages reported in 2000 - 2004 by the Renewable Fuels Association<sup>16</sup>, see **Table 3**.

The national ethanol industry average of 2.6 gal/wet bushel, inflated at least 5% by volume, is 98% of the theoretical average for Illinois. This industry average includes dry and wet mill plants, some of which are 20 years old. The jump of 0.2 gal/bu in 2004 can be attributed to

<sup>16</sup> As of Feb. 7, 2006, the data shown in Table 3 are still available at <http://www.ksgrains.com/ethanol/uset.html>. The newly redesigned website of the Renewable Fuels Association, <http://www.ethanolrfa.org>, no longer posts the corn bushels used to produce ethanol. Therefore Table 3 could not be extended beyond 2004.

counting ethanol imports from Brazil<sup>17</sup> and  $\sim 2\%$  of other distillation fractions, e.g., fusel alcohol<sup>18</sup>, as ethanol produced in the U.S. **Figure 13** compares the various estimates from 2000 to 2004. In 2005, the industry stopped reporting corn bushels used to produce ethanol.

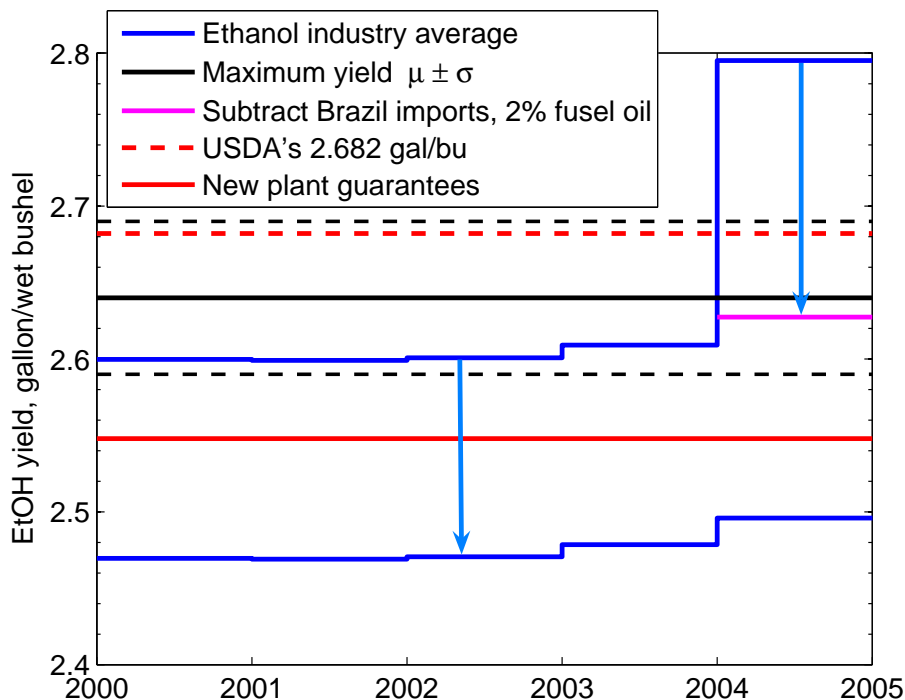

Figure 13: The self-reported ethanol industry yield for all plants has been close to 2.6 gal/wet bushel. The jump to 2.8 gal/wet bushel in 2004 seems to have been caused by counting 0.14 billion gallons (denatured) of ethanol imported from Brazil and additional 2% of the fusel fraction as ethanol produced in the U.S. The upper arrow denotes my correction. Ethanol yield data source: Renewable Fuels Association's 2004 Ethanol Industry Outlook <http://www.ksgrains.com/ethanol/useth.html>. The mean result of the Illinois 2005 Variety Test in Figure 12 is shown as the black line. The broken black lines denote  $\pm$  one standard deviation from the theoretical mean of 2.64 gal/bu. It follows that the ethanol industry's U.S. average for all plants (blue line), new and 20-years old, is 98% of the theoretical stoichiometric ethanol yield (black line), and above the guaranteed ethanol yield in the new most efficient plants (Morris, 2005), red line. The industry average must therefore be discounted by at least 5% (the lower arrow).

<sup>17</sup>Between January 1 and November 1, 2004, the U.S. ethanol imports from Brazil were 334,531,283 kg or  $\sim 0.142$  billion gallons of denatured ethanol per year. These Brazilian imports accounted for  $\sim 5\%$  of ethanol produced in the U.S. in 2004. Source: Balanço\_Exp\_Imp\_Etanol\_Brasil\_EUA\_1981-2004-DATAGRO.xls, an Excel spreadsheet with the U.S. - Brazilian balance of ethanol trade between 1981 and 2004, sent to me by Mr. JUAN M. GRANADOS of BiotradeUSA, Inc., March 17, 2006.

<sup>18</sup>ASTM D5798-99 Standard Specification for Fuel Ethanol for Automotive Spark-Ignition Engines allows for up to 2% by volume of higher aliphatic alcohols (C3-C8), see Table 3 in <http://www.nrel.gov/docs/fy02osti/30849.pdf>.

### 3.4 Summary of Ethanol Yield Conclusions

Some 778 corn starch measurements and 2500 corn grain samples from the 2005 Illinois Corn Variety Test have been used to obtain the detailed statistical estimates of the mean extractable corn starch ( $66.19 \pm 1.13\%$ ) and the mean theoretical ethanol yield ( $2.64 \pm 0.05$  gal EtOH/wet bushel). These results demonstrate that the extractable starch content estimate of 66% used in (Patzek, 2004) is correct, see **Table 4**. The ethanol industry's national average of 2.6 gal/wet bushel has been inflated by counting 5 percent by volume of gasoline as ethanol. Consequently, this average is too high, about 98% of the theoretical yield in Illinois, and it is above the more reasonable yield guarantees of 2.55 gal EtOH/wet bushel (Morris, 2005) in the new efficient plants. If the national average is discounted 5% by removing the volume of gasoline counted as ethanol, it becomes 2.46 gal/bushel, somewhat above my estimate of 2.30 gal/bushel in (Patzek, 2004), which also discounts heavy alcohols. After subtracting ethanol imports from Brazil, the average ethanol yield in 2004 was discounted by another 2% to bring it below the mean theoretical yield calculated here.

**Remark 10** The USDA estimate of 2.682 gallons of 100% pure ethanol per nominal wet bushel of corn with 15% of moisture by weight has been accepted as the basis of net energy calculations in (Farrell et al., 2006a; Farrell et al., 2006c). Based on the analysis here, this USDA estimate is incorrect. □

In 2004, after the correction for #14 gasoline and fusel oil, corn ethanol satisfied less than 1.5% of U.S. motor gasoline consumption, because the 1 psi Reid Vapor Pressure (RVP) waiver for gasoline-EtOH blends was *not* repealed by states fighting increased air pollution<sup>19</sup>. In 2012, with the waiver upheld, ethanol will displace another 1% of U.S. motor gasoline consumption on an energy-equivalent basis. If the waiver is repealed, the lighter gasoline components will be removed in refineries to lower the RVP. The repeal of the waiver would reduce<sup>20</sup> ethanol displacement of conventional gasoline by 30 or 40%. Note that fossil energy use in corn ethanol production has not been accounted for in the above estimates.

Table 4: Average dry mass composition of corn grain (White and Johnson, 2003)

Component	% by mass
Starch	66
Oil	3.9
Gluten feed (21% protein)	24
Gluten meal (60% protein)	5.7
Losses	0.4

<sup>19</sup>States no longer will have to add corn-based ethanol or MTBE to gasoline to fight pollution – a requirement that costs as much as 8 cents a gallon – under rules announced on February 15, 2006, by the Environmental Protection Agency. They eliminate a mandate from the 1990 Clean Air Act that gasoline used in metropolitan areas with the worst smog contain 2 percent oxygen by weight. The law did not say which oxygenate must be used, but most refiners use either ethanol or methyl tertiary butyl ether, known as MTBE. Source: Associated Press, Feb. 15, 2006.

<sup>20</sup>(Source: *Potential Supply Impacts of Removal of 1-Pound RVP Waiver*, September 2002, Office of Oil and Gas of the EIA, Mary J. Hutzler (202-586-2222, mhutzler@eia.doe.gov). The EIA study was requested by Senator Jeff Bingaman, Chairman of the Senate Committee on Energy and Natural Resources).

Table 5: Average high and low heating values of some fossil fuels from (Castorph et al., 1999; Bossel, 2003; Spiers, 1961). Other sources are listed in the footnotes.

Fuel	Density kg/sm <sup>3</sup>	HHV <sup>a</sup> MJ/kg	LHV <sup>a</sup> MJ/kg	HHV <sup>a</sup> MJ/kg	LHV <sup>a</sup> MJ/kg	Source <sup>i</sup>
Gasoline	720-800	46.7 <sup>b</sup>	42.5 <sup>b</sup>	46.8	43.6	Table 339
Diesel fuel	840	45.9	43.0	45.3	42.3	Table 350
Methane	0.66 <sup>d</sup>	55.5 <sup>c</sup>	50.1 <sup>c</sup>	55.1(gas)		Table 347
LPG <sup>e</sup>	0.58	50.0	46.0			
NG <sup>f</sup>	0.84	48.7	43.9			
Ethanol	787 <sup>h</sup>	29.7 <sup>g</sup>	26.7 <sup>g</sup>	29.6	26.8	Table 353
Corn grain dry		18.8 <sup>j</sup>				
Corn stover <sup>k</sup>		17.7	16.5			
Corn stalks <sup>l</sup>		15.8	14.8			
Corn meal <sup>m</sup>		16.0				
Corn oil <sup>n</sup>	909.5	39.5	38.8			

<sup>a</sup>HHV = High Heating Value; LHV = Low Heating Value

<sup>b</sup>Average of gas station fuels, I choose the mean density of 740 kg/m<sup>3</sup>, The leftmost gasoline, diesel fuel, LPG, and NG data are from (Castorph et al., 1999)

<sup>c</sup>From BOSSEL, Table A, (Bossel, 2003)

<sup>d</sup>(Lide, 1994), 6-25

<sup>e</sup>A mixture of propane and butane, C<sub>3</sub>H<sub>8</sub> and C<sub>4</sub>H<sub>10</sub>

<sup>f</sup>An average of natural gas compositions from Groningen, Orenb., Ekofisk, and Leman Bank

<sup>g</sup>[http://bioenergy.ornl.gov/papers/misc/energy\\_conv.html](http://bioenergy.ornl.gov/papers/misc/energy_conv.html)

<sup>h</sup>(Lide, 1994), 15-46

<sup>i</sup>(Spiers, 1961)

<sup>j</sup>Based on the mean of the values reported by SCHNEIDER & SPRAQUE (1955), p. 496, 2033 kcal/lb; and MILLER (1958), p. 639, 2059 kcal/lb. 1 thermochemical kcal = 4.184 kJ

<sup>k</sup>The mature corn stalks of corn from which the ears have been removed. (Domalski et al., 1987), p. 16

<sup>l</sup>(Domalski et al., 1987), p. 17

<sup>m</sup>*Zea mays*, 11.79% moisture (Domalski et al., 1987), p. 93

<sup>n</sup>Liquid vegetable oil (Domalski et al., 1987), p. 223

## 4 Co-Products Receive Energy Credit

Now I will focus on a modern dry grind ethanol refinery sketched in **Figure 27**. Because corn grain is a nascent or “baby” fossil fuel, it takes a lot of energy to transform it into ethanol, cf. Remark 4.

To demonstrate this fact, I will start from quoting the best existing written performance guarantee by ICM, Inc., 310 North First Street, Colwich, Kansas 67030, ([www.icminc.com](http://www.icminc.com)):

1. Ethanol yield: 2.80 gallons per bushel<sup>21</sup> (denatured)
2. Natural gas use: 34,000 Btu per gallon of ethanol (denatured)
3. Electricity use: 0.75 kWh per gallon of ethanol (presumably denatured too)<sup>22</sup>.

<sup>21</sup>With an unspecified moisture content.

<sup>22</sup>The actual energy bills paid by ethanol refineries in South Dakota point to about 40,000 Btu and 1.95 kWh per

After removing 5% of #14 gasoline, the yield is  $2.8 \times 0.95 = 2.66$  gal/bu of ethanol, plus 2% of isobutyl and isopropyl alcohol, see Footnote 18. If the latter were true, there would be  $2.66 \times 0.98 = 2.60$  gal/bu ethanol in the final mixture, which is still an incredible 98% of the mean theoretical ethanol yield calculated in Section 3. As long as the processed corn is old and dry (has less than 15% of moisture by weight) the yield guarantee can be met, otherwise it is unlikely<sup>23</sup>.

Natural gas use is  $9.48/0.95 = 9.98$  MJ/L of gasoline-free product. Electricity use is  $0.71/0.95 = 0.75$  MJ/L of gasoline-free product. As primary energy, this electricity is about 3 times more or 2.25 MJ/L. Primary fossil energy necessary to produce the product mixture is therefore 12.23 MJ/L or 15.5 MJ/kg.

**Remark 11** Even in the most efficient ethanol refinery, one spends 15.5/26.7, i.e., an equivalent of 58% of the low heating value of ethanol, on direct refining costs. This number should be compared with an average energy ratio for refining crude oil, ~12% for diesel fuel (or gasoline), in an average U.S. refinery, see Footnote 8. Thus, excluding corn grain/ethanol transportation energy, it takes 5 times more fossil energy to produce corn ethanol in the best biorefinery than gasoline or diesel fuel from crude oil in an average petroleum refinery.  $\square$

As shown in **Figures 14** and **15**, both based on the data published by (Morris and Ahmed, 1992), ICM, Inc., (Patzek, 2004), and (Sheehan et al., 1998), the average fossil energy expended in ethanol refineries is 7 times that in petroleum refineries.

**Remark 12** From a purely energetic point of view, corn grain refining to ethanol and the associated transport logistics are poor choices. Corn is a widely dispersed, low energy-density source, and it cannot be piped. Similarly, ethanol cannot be piped. Thus, energy costs of corn and ethanol transportation can be as high as 3 MJ/L of ethanol for a refinery on the East or West Coast<sup>24</sup>.  $\square$

A careful look at Figure 27 reveals that starch liquefaction is the stage at which liquid glucose *could* be separated from corn grain solids and corn oil. The solids could then be sent directly to the centrifuge and drum drier. All of these operations do not involve distillation. Therefore, it is not entirely correct to subtract  $4.1/0.95 = 4.3$  MJ/L of ethanol, or roughly 50% of the natural gas expenditure in an ICM plant. This subtraction also makes little sense based on (Patzek, 2004), where I argued that most corn processing coproducts should be returned to the fields to limit the egregious irreversibility and unsustainability of industrial corn farming (Tegtmeier and Duffy, 2004).

The net heating value of ethanol production coproducts<sup>25</sup> might be subtracted from the heating value of corn grain, but *not* from the fossil energy spent on distilling corn beer. Again, since corn grain has no calorific value in the Report and in the literature sources it accepts (Wang et al., 1997; Wang, 2001; Shapouri et al., 2002; Shapouri et al., 2003; Shapouri and McAloon, 2004), the authors subtract the calorific value of DDGS (about 1/3 of corn grain energy) from the fossil energy spent on ethanol distillation.

Finally, the DDGS coproduct energy credits do not scale up, see **Figure 16**. Suppose that we wanted to feed cattle with the main by-product of transforming all U.S. corn into ethanol, DDGS. There would be enough DDGS to feed 180 million cows, twice as much as the head count of all

---

gallon of ethanol. Source: The South Dakota Public Utilities Commission. Private communication, April 7, 2006.

<sup>23</sup>Note that the imprecise, ill-defined units used by the U.S. ethanol industry offer some leeway. For example, in a report on the Gopher dry mill plant in St. Paul, MN, (Anonymous, 2003), the mean ethanol yield is 2.5 gal/bu, but 1 bushel weighs 68.5 lbm, not 56 lbm, as it is supposed to, see page 4.

<sup>24</sup>*Estimating Ethanol Logistics Cost and Energy Use*. Personal communication, Dr. David Hirshfeld, MathPro, Washington D.C., Jan. 27, 2006.

<sup>25</sup>The LHV or HHV of coproducts - Sum of Process Energies of Separation and Drying.

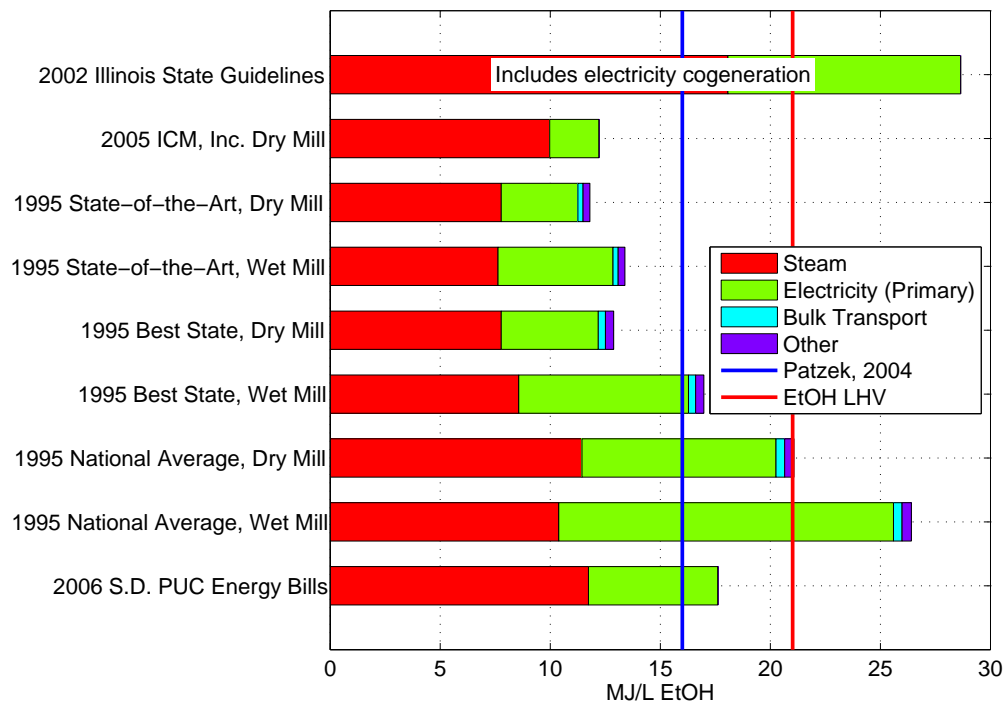

Figure 14: Fossil energy used in ethanol refineries. The blue vertical line is my average estimate (Patzek, 2004). Other sources are: The ICM written guarantee, the 1995 update of MORRIS & AHMED (1992), and [www.iletohprefeas.com/include/input.pdf](http://www.iletohprefeas.com/include/input.pdf) for the 2002 Illinois Guidelines for potential ethanol plant builders. The Low Heating Value (LHV) of ethanol, i.e., the amount of energy one obtains from combusting it in a car engine, is the red vertical line. The ICM and MORRIS & AHMED’s data were discounted by taking out 5 volume percent of gasoline. Note that the 1995 U.S. national average for dry mills *is* the LHV of ethanol. Also note that my estimate (Patzek, 2004) is a little better than the “Best State” wet mill.

cows in the U.S. Cows have evolved to digest grass (ruminant) and cannot be fed DDGS alone. Cow feedlot managers suggest using up to 3 pounds of DDGS per day per cow to prevent the cows from getting sick and being pumped full of antibiotics.

## 5 System Boundaries, Mass, and Energy Balance

Let me now discuss how FARRELL *et al.* (2006a; 2006c) have failed to define the system boundaries and perform proper mass and energy balances. The authors claim to use “commensurate system boundaries,” to arrive at their net energy ratios for corn ethanol, but never define these boundaries, thus violating the strongest recommendations in (Slessor, 1974; Slessor, 1975), (Hall and Day, 1977), and (Patzek, 2004). As stated clearly in (Patzek, 2004), mass and energy inputs and outputs (fluxes) can only be defined *relative* to a system boundary. In other words, a system without a clear boundary cannot be properly described and the most fundamental axioms of science: mass and energy conservation will be violated.

Here, following (Patzek, 2004), the system boundary is defined as in **Figure 17**. Subsystem I

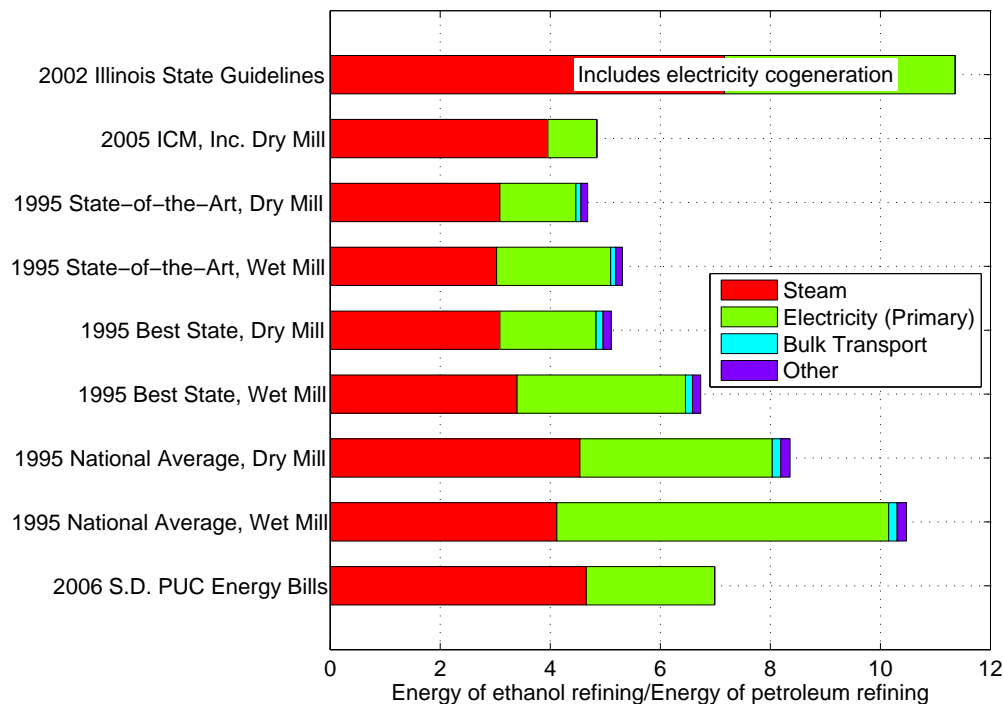

Figure 15: Ratio of energy used to refine corn grain to ethanol and energy used to refine crude oil to diesel fuel or gasoline. The calculations are based on the data shown in Figure 14 and on the NREL report (Sheehan *et al.*, 1998). The mean ratio is 7.

encloses the corn fields<sup>26</sup> and plants. Subsystem I operates in annual cycles, and is refilled with the supply of corn seeds, soil nutrients, soil water, and heavy subsidies from ancient carbon fuels, minerals, and machinery. The 30-year average year-around solar *irradiance*<sup>27</sup> of a flat horizontal surface in Des Moines, Iowa, is 200 W/m<sup>2</sup>. The corresponding annual irradiation of 1 ha is therefore 63000 GJ. The all time highest average crop in Iowa has been 181 bushels/acre or 9700 kg of dry corn grain/ha. The biomass energy sequestered in this crop is, see Table 5, 18.8 MJ kg<sup>-1</sup> × 9700 kg ha<sup>-1</sup> = 182 GJ ha<sup>-1</sup>. Accounting for the stalk and roots, the total biomass energy is about 360 GJ ha<sup>-1</sup>, or 360/63000 = 0.006 of the annual *irradiation* energy. Thus, almost all solar energy is reflected, radiated, thermally conducted, and convected with water evaporated from the soil and plants. From the point of view of biomass sequestration the sun acts as a *catalyst* (Patzek, 2004). Subsystem I operates at two vastly different energy scales: The solar energy megascale, and the chemical/fossil energy microscale. The megascale solar energy balance is not pertinent to the chemical/fossil microscale energy balance performed here.

Subsystem II encloses ethanol refineries, their soil, and local surface and subsurface water resources. Subsystem III encloses machines that convert chemical energy in corn ethanol into a flow of electricity through fuel-cell cars or electrical power stations. Subsystem III is defined this way to keep the free-energy efficiency comparisons consistent among solar cells, wind turbines, and biofuel cycles, for details see (Patzek, 2004) and (Patzek and Pimentel, 2006). Subsystem III is not relevant to the discussion of this paper.

<sup>26</sup> Additional field area for hybrid corn breeding should also be included.

<sup>27</sup> For definitions and details, see my Fall 2005 CE24 Lecture, <http://petroleum.berkeley.edu/patzek/ce24/-Fall2005/Materials/PlantEfficiency.pdf>



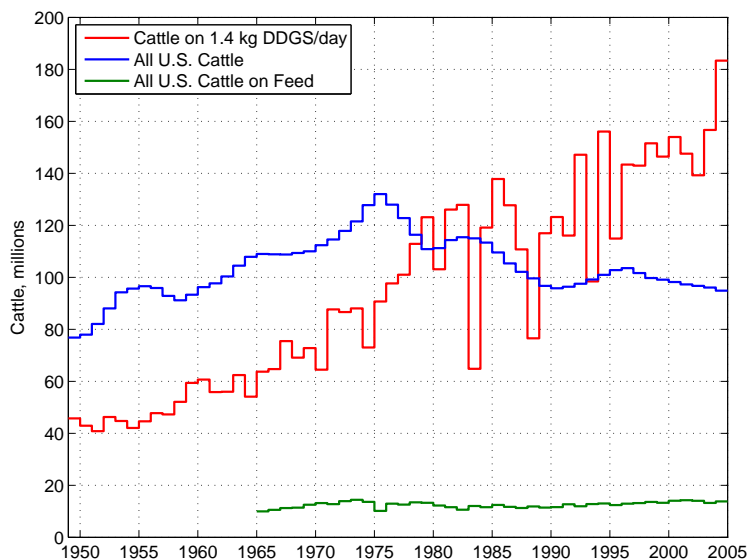

Figure 16: Sources: USDA NASS, Kansas Corn Growers, Patzek 2004.

## 5.1 How to Analyze the Corn-Ethanol Cycle?

Any scientific analysis of an open, possibly steady-state, corn-ethanol system must fulfill these two old<sup>28</sup> principles of science that, when properly applied, account for all processes, old and new:

1. The law of mass conservation (LAVOISIER, ca. 1780)
2. The law of energy conservation (JOULE, CLAUSIUS, THOMSON, ca. 1840)

If the mass balance of the system is violated, so is the corresponding energy balance.

Following classical thermodynamics, e.g., (Planck, 1926; Stodola, 1927; Hatsopoloulos and Keenan, 1965; Abbott and Van Ness, 1972), I will now write the steady-state mass and energy balances for Subsystems I and II and discuss the shortcomings of Eqs. (S-1) – (S-7) in SOM:

$$\sum \text{Inputs per unit area and time} = \sum \text{Outputs per unit area and time} \quad (7)$$

Each of the mass and energy inputs will be specified in words.

## 5.2 The Mass Balances of Subsystems I-II

(Farrell et al., 2006a; Farrell et al., 2006c) have written no mass balances. The mass-balance terms, therefore, must be *inferred* from the corresponding terms in their energy balance. It turns out that (Farrell et al., 2006a; Farrell et al., 2006c) use some of the inputs and outputs in the mass balance of the industrial corn-ethanol cycle, but never close this balance (their included steady-state inputs are labeled “(I)”). In other words, in their calculations, (Farrell et al., 2006a; Farrell et al., 2006c) *never* conserve mass and, by implication, energy. The algebraic expressions that involve arbitrary

<sup>28</sup>(Farrell et al., 2006a) write this about (Patzek, 2004; Pimentel and Patzek, 2005): “[T]wo studies also stand apart from the others by incorrectly assuming that ethanol coproducts (materials inevitably generated when ethanol is made, such as dried distiller grains with solubles, corn gluten feed, and corn oil) should not be credited with any of the input (sic!) energy and by including some input data that are old and unrepresentative of current processes, or so poorly documented that their quality cannot be evaluated (tables S2 and S3).”

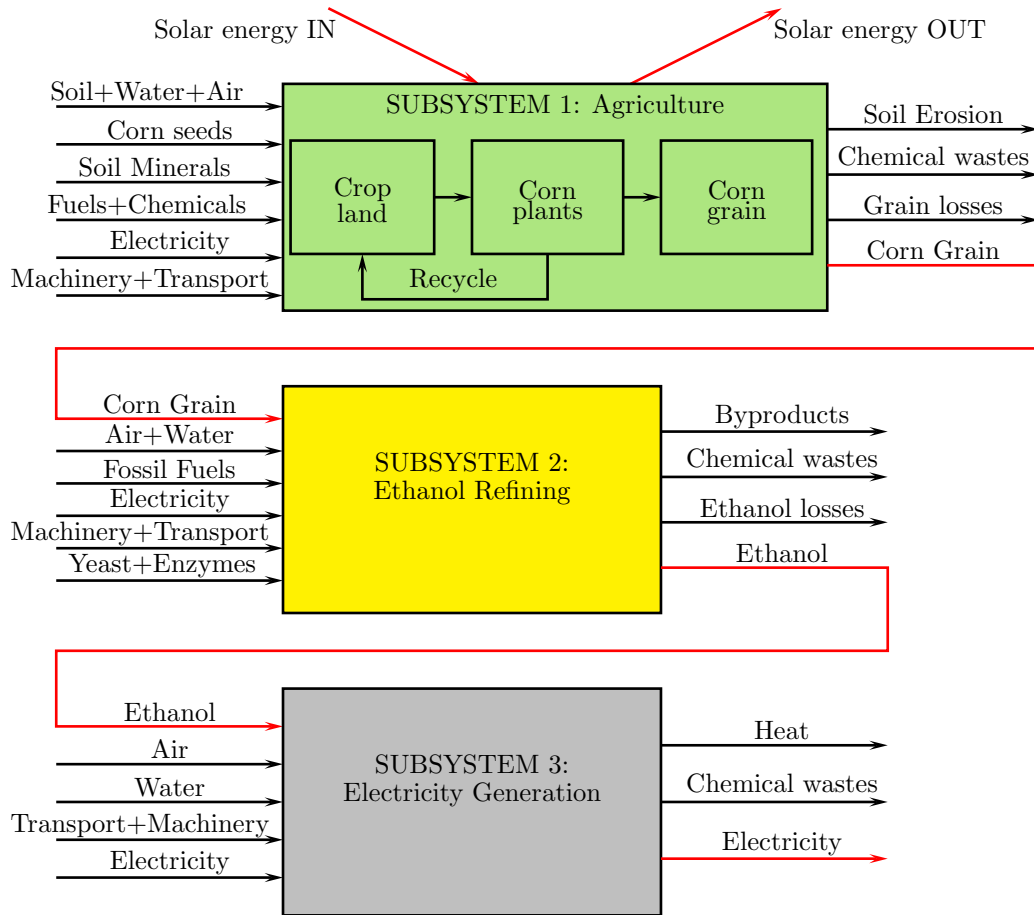

Figure 17: The corn  $\rightarrow$  ethanol  $\rightarrow$  electricity system consists of three subsystems in series. In these subsystems, the energy costs of labor have been omitted. The low-quality heat generated in Subsystems 1 and 2 has also been neglected. It is assumed that corn stalk is decomposed and recycled to improve soil structure. The DDGS byproduct output of Subsystem 2, and the  $\text{CO}_2$  produced in Subsystems 1–3, become inputs to Subsystem 1, thus creating an incomplete carbon cycle, and partially recycling other nutrients. The contaminated water outputs can also become inputs after purification, creating a partial water cycle, see (Patzek, 2004), Part III.

energy terms (Eqs. (S-1) – (S-7) in (Farrell et al., 2006c)) are *never* equivalent to defining the system boundaries, contrary to the strenuous denial in (Farrell et al., 2006b), p. 1748.

Properly speaking, all terms in the mass balance equations are *fluxes* and their units are  $\text{kg m}^{-2} \text{s}^{-1}$ , or  $\text{kg ha}^{-1} \text{s}^{-1}$ , or  $\text{kg ha}^{-1} \text{yr}^{-1}$  ( $1 \text{ ha} = 10000 \text{ m}^2$ ):

### 5.2.1 Mass Balance of Corn Farming (Subsystem I)

$$\begin{aligned}
 & 1. \text{ Mass of Corn Seeds (I) +} \\
 & 2. \text{ Mass of CO}_2 \text{ from Air +} \\
 & 3. \text{ Mass of Mineral Uptake by Corn Plants (I) +} \\
 & 4. \text{ Mass of Pesticide and Herbicide Uptake (I) +} \\
 & 5. \text{ Mass of Water In =} \\
 & 6. \text{ Mass of Corn Plants (Grain (I) + Stalk + Roots) +} \\
 & 7. \text{ Mass of Effluent Liquids (Water + Aqueous Chemicals) +} \\
 & 8. \text{ Mass of Effluent Solids (Plant Parts) +} \\
 & 9. \text{ Mass of Effluent Gases (O}_2\text{, CO}_2\text{, H}_2\text{O, etc.)}
 \end{aligned} \tag{8}$$

### 5.2.2 Overall Mass Balance of Soil (Subsystem I)

$$\begin{aligned}
 & 1. \text{ Mass Corn Stalk + Roots + Other Recycled Plant Parts/Animals +} \\
 & 2. \text{ Mass of Weathered Minerals and Soil from Inundations +} \\
 & 3. \text{ Mass of Soil Restoration Materials +} \\
 & 4. \text{ Mass of Human Mineral Inputs to Soil (I) =} \\
 & 5. \text{ Mineral Uptake by Plants and Animals +} \\
 & 6. \text{ Mass of Eroded Topsoil (Effluent+Dust) +} \\
 & 7. \text{ Mass of Effluent Gases and Aerosols (O}_2\text{, CO}_2\text{, CO, NH}_3\text{, NO}_x\text{, SO}_x\text{, etc.)}
 \end{aligned} \tag{9}$$

In industrial corn farming the soil mass balance is seldom steady-state because soil erosion and mineral withdrawal from soil mineral store often exceed mineral and plant inputs. Also, individual mineral component mass (and energy) balances must be performed separately. For example, the overall mass balance of human fertilizers:

$$\begin{aligned}
 & \text{Mass of Human Mineral Inputs =} \\
 & \text{Mass of Human Mineral Uptake by Corn Plants +} \\
 & \text{Mass of Human Mineral Uptake by Soil +} \\
 & \text{Mass of Human Minerals in All Effluents}
 \end{aligned} \tag{10}$$

needs to be split into N, P, K, Mg, Ca, S, etc. mass balances, not all of which will be steady-state. For multiple examples of such calculations, see, e.g., (Patzek and Pimentel, 2006).

### 5.2.3 Mass Balance of Corn Processing (Subsystem II)

$$\begin{aligned}
 & 1. \text{ Mass of Corn Grain In} + \\
 & 2. \text{ Mass of Fossil/Synthetic Chemical Inputs to Corn Processing (I)} + \\
 & 3. \text{ Mass of Yeast and Enzyme Inputs to Corn Processing} + \\
 & 4. \text{ Mass of Water In} + \\
 & 5. \text{ Mass of O}_2 \text{ from Air, SO}_2, \text{ etc.} = \quad (11) \\
 & 6. \text{ Mass of Alcohols Out (I)} + \\
 & 7. \text{ Mass of DDGS Out (I)} + \\
 & 8. \text{ Mass of Other Distillation Byproducts} + \\
 & 9. \text{ Mass of Solid, Liquid, and Gaseous Effluents from Corn Processing}
 \end{aligned}$$

The overall mass balance of corn processing is violated in (Farrell et al., 2006a; Farrell et al., 2006c). Note that for 1 kg of corn grain input in a biorefinery there are 10–15 kg of process water inputs. Much of this water is evaporated, and some is recycled.

Terms 1, 6, 7, 8 and 9 in equation (11) can be extracted from Eq. (11) to yield just the balance of *corn mass*:

$$\begin{aligned}
 & \text{Mass of Corn Grain In} = \\
 & \text{Mass of Alcohols Out (I)} + \\
 & \text{Mass of DDGS Out (I)} + \quad (12) \\
 & \text{Mass of Other Distillation Byproducts} + \\
 & \text{Mass of Some Solid, Liquid, and Gaseous Effluents from Corn Processing}
 \end{aligned}$$

## 5.3 The Energy Balances of Subsystems I-II

Properly speaking, all terms in the energy balances below should have units of power fluxes  $\text{J m}^{-2} \text{s}^{-1}$ , or  $\text{MJ ha}^{-1} \text{crop}^{-1}$ , or  $\text{GJ ha}^{-1} \text{yr}^{-1}$ .

### 5.3.1 Energy Balance of Corn Farming (Subsystem I)

$$\begin{aligned}
 & 1. \text{ Energy in Corn Seeds (I)} + \text{Photosynthetic Solar } h\nu \text{ m}^{-2} \text{ s}^{-1} + \\
 & 2. \text{ Energy of CO}_2 \text{ from Air} + \\
 & 3. \text{ Energy of Mineral/Chemicals Uptake by Plants (I)} + \\
 & 4. \text{ Energy of Water In} = \quad (13) \\
 & 5. \text{ Energy of Corn Plants (Grain + Stalk + Roots)} + \\
 & 6. \text{ Energy of Effluent Liquids (Water + Aqueous Chemicals)} + \\
 & 7. \text{ Energy of Effluent Solids (Plant Parts)} + \\
 & 8. \text{ Energy of Effluent Gases (O}_2, \text{ CO}_2, \text{ H}_2\text{O, etc.)}
 \end{aligned}$$

Note that some of the energy fluxes are close to zero (2), or are defined to be zero at standard conditions (4). The photosynthetic solar energy flux is a tiny fraction of solar irradiance. The fundamental energy balance (13) of corn farming is violated in (Farrell et al., 2006a; Farrell et al., 2006c).

### 5.3.2 Overall Energy Balance of Soil (Subsystem I)

$$\begin{aligned}
& 1. \text{ Net Solar Energy into Soil} + \\
& 2. \text{ Energy of Corn Stalk} + \text{ Roots} + \text{ Other Recycled Plant Parts/Animals} + \\
& 3. \text{ Energy of Weathered Minerals and Their Aqueous Solutions} + \\
& 4. \text{ Energy of Human Mineral Inputs (I)} + \\
& 5. \text{ Soil Restoration Work} + \\
& 6. \text{ Fossil Energy of Soil Reworking and Irrigation (I)} = \\
& 7. \text{ Energy Stored in Soil Structure} + \\
& 8. \text{ Energy of Mineral Uptake by Plants and Animals} + \\
& 9. \text{ Energy of Eroded Topsoil (Effluent+Dust)} + \\
& 10. \text{ Energy of Effluent Gases and Aerosols (O}_2\text{, CO}_2\text{, CO, NH}_3\text{, NO}_x\text{, SO}_x\text{, etc.)}
\end{aligned} \tag{14}$$

Note that the soil energy balance is seldom steady-state. The fundamental energy balance (14) of soil is violated in (Farrell et al., 2006a; Farrell et al., 2006c).

### 5.3.3 Overall Energy Efficiency of Corn Farming (Subsystem I + Environment)

If one assumes for simplicity that the calorific value of corn grain is equal to the solar energy sequestered as corn grain, then the overall energetic efficiency of industrial corn farming can be defined as:

$$\begin{aligned}
\eta_{\text{corn grain}} &= \frac{1}{1 + \sum \text{Farming Energy Inputs} + \sum \text{Restoration Work Inputs}} \\
\eta_{\text{corn grain}} &= \frac{\text{Output Corn Energy}}{\text{Sequestered Solar Energy}} \frac{1}{1 + \sum \text{Fossil/Environmental Energy Subsidy Fractions}}
\end{aligned} \tag{15}$$

where the dimensionless Farming Energy Inputs, Restoration Work Inputs, and their sum, Energy Subsidy Fractions, have the units of MJ/MJ in sequestered solar energy. The second term in Eq. (15)<sub>2</sub> describes energy losses in industrial corn agriculture. In perfect solar-driven agriculture  $\eta_{\text{corn grain}} \equiv 1$ .

Most energy balances ignore the environmental impacts of industrial farming, which are very high (Tegtmeier and Duffy, 2004); exceptions are rare, e.g., (Berthiaume et al., 2001) and (Patzek, 2004), Part III. The first sum in the denominator is about 0.2, see (Patzek, 2004), Part I, or  $\sim 0.4$  when the environmental impacts of direct fossil energy inputs to corn farming are also considered, see Part III. The second sum contains a relatively small Term 5 in Eq. (14), and a very large work term to restore the environment of the open corn fields Subsystem I. This work is external to Eq. (14) and has not been included yet in (Patzek, 2004). The energy needed to perform restoration work must originate from the corn-ethanol cycle, other environmental resources, and fossil energy inputs. For example, the ethanol coproducts can serve to restore the corn fields and get proper energy credit, see Section 5.5 for more discussion.

The second sum could certainly exceed 0.8 for the increasingly degraded industrial farming ecosystems (Ho and Ulanowicz, 2005). A conservatively low value<sup>29</sup> for Iowa today might be 0.4

<sup>29</sup>It is difficult to grasp the scale of the ecosystem restoration problem. For example, in 1997, 20,500 gigatonnes/yr of N were injected into the U.S. environment from distributed human sources; one third was exported (Howarth et al., 2002). More than 60 percent of our coastal rivers and bays in every coastal state of the continental United States are

(0.2 for the Subsystem I restoration work (Patzek, 2004) plus 0.2 for the environment restoration work), see also Section 7.1. With this assumption,

$$\eta_{\text{corn grain}} = \frac{1}{1 + 0.2 + (0.2 + 0.2)} = 0.63 \quad (16)$$

### 5.3.4 Energy Balance of Corn Processing (Subsystem II)

To understand the delicate question of DDGS energy credits, we must perform the following detailed energy balance of the biorefinery in **Figure 27**:

$$\begin{aligned} & 1. \text{ Energy of Corn Grain} + \\ & 2. \text{ Energy of Fossil/Synthetic Chemical Inputs to Corn Processing (I)} + \\ & 3. \text{ Energy of Yeast and Enzyme Inputs to Corn Processing} + \\ & 4. \text{ Energy of Water In} + \\ & 5. \text{ Energy of O}_2 \text{ from Air, SO}_2 \text{, etc.} = \quad (17) \\ & 6. \text{ Energy of } \mathbf{Concentrated} \text{ Alcohols Out (I)} + \\ & 7. \text{ Energy of } \mathbf{Dry} \text{ DDGS Out (I)} + \\ & 8. \text{ Energy of Other Distillation Byproducts} + \\ & 9. \text{ Energy of Solid, Liquid, and Gaseous Effluents from Corn Processing} \end{aligned}$$

This overall energy balance of biorefinery is violated in (Farrell et al., 2006a; Farrell et al., 2006c).

**Remark 13** If we drop the requirement that the alcohols in Term 6 be **concentrated** and the DDGS in Term 7 be **dry**, Terms 1, 6, 7, 8 and 9 in equation (17) can be extracted to balance just the *corn grain energy*, which tells us *only* that the energy of the *dilute* (8-12%) alcohol solution, plus the energy of the *aqueous suspension* of the non-starch solids and corn oil, balance almost exactly the energy in corn grain. This is approximately true because (1) the beer water and effluent CO<sub>2</sub> have almost no energy, and (2) starch cooking and hydrolysis consume some heat, but glucose fermentation generates an almost equal amount of heat. □

The corn energy balance in the Slurry tank + Jet cooker + Liquefaction + Fermentation part of biorefinery is

$$\begin{aligned} & \text{Energy in Corn Grain} = \\ & \text{Energy in Corn Ethanol (I) \& Other Alcohols} + \text{Energy in DDGS (I)} + \\ & \text{Energy in Other Distillation Byproducts} + \\ & \text{Energy in Some of Effluents} \quad (18) \end{aligned}$$

This corn energy balance in the refinery is also violated in (Farrell et al., 2006a; Farrell et al., 2006c).

Now we can check if the assertion in **Remark 13** is correct, and the mass and energy balance equations, (12) and (18), are consistent with the data in Tables 4 and 5. In keeping with the customary industry units, let me base the energy balance on 1 standard bushel of corn, or 56 lbm

---

moderately to severely degraded by nutrient pollution. This degradation is particularly severe in the mid Atlantic states, in the southeast, and in the Gulf of Mexico (Howarth, 2000) Therefore, ground and surface water restoration will add to the Restoration Work Inputs another term that may be significantly larger than 1.

of corn grain that contains 15% of moisture by weight, or 21.6 kg of bone dry grain. From the calculations in Section 3.2, it follows that with *zero losses*<sup>30</sup>, this bushel will yield 2.639 gallons of 100% ethanol or 7.86 kg of pure ethanol. The combined mass and energy balances now yield the following:

$$\begin{aligned}
 & 21.6 \text{ kg/bushel} \times 18.8 \text{ MJ/kg (Energy in Corn Grain)} = \\
 & 7.86 \text{ kg/bushel} \times 29.7 \text{ MJ/kg (Energy in Corn Ethanol)} + \\
 & 0.297 \times 21.6 \text{ kg/bushel} \times 18.8 \text{ MJ/kg (Energy in non-starch solids)} + \\
 & 0.039 \times 21.6 \text{ kg/bushel} \times 39.5 \text{ MJ/kg (Energy in corn oil)} + \\
 & 0.045 \times 21.6 \text{ kg/bushel} \times 18.8 \text{ MJ/kg (Energy in Losses)}
 \end{aligned} \tag{19}$$

or

$$\begin{aligned}
 & 406 \text{ MJ/bushel (Energy in Corn Grain)} = \\
 & 233 \text{ MJ/bushel (Energy in Corn Ethanol)} + \\
 & 103 \text{ MJ/bushel} + 33 \text{ MJ/bushel (Energy in DDGS)} + \\
 & 18 \text{ MJ/bushel (Energy in Losses)}
 \end{aligned} \tag{20}$$

Thus, the corn processing energy balance, consistent with the corresponding mass balance, is  $406 \approx 387$  MJ/bushel, i.e., it closes to within 5%. This is not bad at all, considering the inaccuracies in measuring the high heating values of the non-starch parts of corn grain that – mixed together – form DDGS. Also the energy in mash cooking, starch liquefaction, and fermentation, as well as in the liquid and gaseous effluents has been neglected.

Note that at this stage we have balanced the *output* energy of dilute corn beer, and dilute solid suspension of the non-starch portion of corn grain and yeast, with the *input* energy of corn grain. This beer must now be *concentrated* from ~10% to 100% of ethanol, and the solids must be separated from water and dried. Ethanol concentration by multi-stage distillation is an extremely energy-intensive process. It is done in the Distillation and Drum Dryer section of the biorefinery in **Figure 27**. Almost *all* of the fossil energy in the biorefinery is spent on the beer distillation and DDGS separation and drying, see Section 4 and **Figure 14**.

**Remark 14** To close the complete biorefinery energy balance equation (17), the fossil energy spent on distillation should be added as the second energy input after corn grain, i.e., the input energy in yeast and enzymes will be neglected for now.  $\square$

Now we are ready to perform the complete energy balance of the dry grind corn biorefinery. I will use the most optimistic ICM estimate of the distillation/drying energy, 15.5 MJ/kg of ethanol + butanol + isopropanol + etc. I will also charge the refinery with 1.5 MJ/kg in wastewater cleanup, and grain, alcohol and DDGS transportation costs<sup>31</sup>.

$$\begin{aligned}
 & 21.6 \text{ kg/bushel} \times 18.8 \text{ MJ/kg (Energy in Corn Grain)} + \\
 & 7.86 \text{ kg/bushel} \times (15.5 + 1.5) \text{ MJ/kg (Fossil Energy)} = \\
 & 7.86 \text{ kg/bushel} \times 29.7 \text{ MJ/kg (Energy in Distillation Products)} + \\
 & 0.297 \times 21.6 \text{ kg/bushel} \times 18.8 \text{ MJ/kg (Energy in non-starch solids)} + \\
 & 0.039 \times 21.6 \text{ kg/bushel} \times 39.5 \text{ MJ/kg (Energy in corn oil)} + \\
 & \text{All Energy Losses in Corn Processing}
 \end{aligned} \tag{21}$$

<sup>30</sup>Note that I am using here the *maximum theoretical yield* of ethanol based on the real data presented in Section 3.2. No industrial facility exceeds 85-95% of this yield for a long time. Thus, the counter-argument in (Farrell et al., 2006b), quoted in Footnote 11, is not quite correct.

<sup>31</sup>In (Patzek, 2004), this energy cost was 2 times higher.

or

$$\begin{aligned}
 & 406 \text{ MJ/bushel (Energy in Corn Grain)} + \\
 & 134 \text{ MJ/bushel (Energy in Fossil Fuels)} = \\
 & 233 \text{ MJ/bushel (Energy in Distillation Products)} + \\
 & 136 \text{ MJ/bushel (Energy in DDGS)} + \\
 & 171 \text{ MJ/bushel (All Energy Losses in Corn Processing)}
 \end{aligned} \tag{22}$$

The overall biorefinery efficiency is defined as

$$\begin{aligned}
 \eta_{\text{ethanol}} &= \frac{\text{Output Ethanol Energy}}{\sum \text{Refinery Energy Inputs}} \\
 \eta_{\text{ethanol}} &= \frac{\text{Output Ethanol Energy}}{\text{Input Corn Energy}} \frac{1}{1 + \sum \text{Fossil/Environmental Energy Input Fractions}}
 \end{aligned} \tag{23}$$

where the dimensionless Energy Input Fractions have the units of MJ/MJ in corn grain. The second term in Eq. (23)<sub>2</sub> describes energy losses in a corn-ethanol biorefinery. A perfect solar driven corn-ethanol refinery with the maximum theoretical ethanol yield has  $\eta_{\text{ethanol}} = 233/406 = 0.57$ . In that refinery all coproducts would have to be recycled back to the corn fields to limit fossil energy inputs to agriculture, see Eq. (15) and the stanza at the beginning of this paper.

At this stage, we can calculate efficiency of the best possible ethanol refinery<sup>32</sup> in two different ways:

1. According to Eq. (1):

$$\eta_{\text{ethanol}} = \frac{233}{406 + 134} = 0.43 \tag{24}$$

2. Or, we can attempt to squeeze in the DDGS as another *finished fuel* (Which it is not! See the discussion in Section 5.5)

$$\eta_{\text{ethanol+DDGS}} = \frac{233 + 136}{406 + 134} = 0.68 \tag{25}$$

Note that the best-case ethanol refining is far less efficient than average petroleum refining ( $\eta_{\text{gasoline}} = 0.88$ ). If one replaces the best ICM biorefinery with the 1995 National Average Dry Mill, see Figure 14, the second term in Eq. (22) increases from 134 to 220 MJ/bushel, and the average biorefinery efficiencies are 0.37 and 0.59, respectively.

To obtain the best overall efficiency of industrial corn-ethanol cycle, the biorefinery efficiencies in Eq. (24) or (25) should be multiplied by the overall corn farming efficiency, Eq. (16). We then get the following.

1. (No DDGS coproduct credit):

$$\eta_1 = \eta_{\text{ethanol}} \times \eta_{\text{corn grain}} = 0.43 \times 0.63 = 0.27 \tag{26}$$

2. (Full DDGS coproduct credit):

$$\eta_2 = \eta_{\text{ethanol+DDGS}} \times \eta_{\text{corn grain}} = 0.68 \times 0.63 = 0.43 \tag{27}$$

---

<sup>32</sup>This refinery operates at the maximum theoretical yield of ethanol all the time; an obvious impossibility.



These efficiencies are 0.23 and 0.37, respectively, for the average dry mill case. All cases shown in Figure 14 are compared in **Figure 18**. By including photosynthetic energy, but also a penalty for the restoration of corn fields, rivers, aquifers, etc., the overall corn-cycle efficiency is still 3 – 4 times lower (without the DDGS energy credit), or  $\sim 2$  times lower (with the DDGS energy credit), than the overall efficiency of gasoline production (0.833). See **Remark 4** for comparison.

So, no matter how we do the calculations, we reach the following conclusion:

**Remark 15** Fossil fuels must be conserved if our civilization is to survive a little longer, see **Figure 19**. From thermodynamics it follows that ecological damage wrought by industrial biofuel production must be severe. □

#### 5.4 What Is Wrong with Net-Energy Analysis?

Equations (S-2) and (S-3) in (Farrell et al., 2006c) do not follow from *any* conceivable mass balance equation for a corn-ethanol system and are inconsistent with the fundamental energy balance equations (13) – (18). In their net-energy analysis, (Farrell et al., 2006a; Farrell et al., 2006c) did *not* (i) define the system boundaries, (ii) close mass balances and, consequently, (iii) conserve energy in violation of the First Law of Thermodynamics.

As already pointed out in (Patzek, 2004), most of the existing net-energy models of the energetics of industrial corn-ethanol cycle are based on nonphysical assumptions and *must* be discarded<sup>33</sup>:

**Remark 16** The net-energy models currently used to evaluate industrial biofuel cycles pick only those terms in the fundamental energy balances that justify *a posteriori* business and/or political outcomes. These models are favored by some engineers, managers, economists and political scientists, see, e.g., (Wang et al., 1997; Wang, 2001; Shapouri et al., 2002; Graboski, 2002; Shapouri et al., 2003; Shapouri and McAloon, 2004; Farrell et al., 2006a), and lead to never-ending discussions (cf. Footnote 28) of the sort: “My net-energy *balance* (sic!) is better than yours because you did/did not include this or that term<sup>34</sup>.” The only hope to achieve progress in the comparison of relative merits of biofuel cycles is to use their *complete* energy balances, and define the *overall* energy efficiencies that account for the horrendous, widespread damage of the environment caused by these cycles (Patzek, 2004; Patzek and Pimentel, 2006; Pimentel and Patzek, 2005). It is time to move away from the ongoing and tedious fossil fuel net energy balance debate and on to the ecological problems that are poorly understood. □

<sup>33</sup>The legendary mathematician and computer scientist JOHN VON NEUMANN, once said (Gaston, 1955): “The sciences do not try to explain, they hardly even try to interpret, they mainly make models. By a model is meant a mathematical construct which, with the addition of certain verbal interpretation, describes observed phenomena. The justification of such a mathematical construct is solely and precisely that it is expected to work - that is, correctly describe phenomena from a reasonable wide area.”

<sup>34</sup>Moreover, the path-independent internal energy or free energy (both functions of state) are commonly mixed up with the path-dependent heat and work flows (ways of exchanging energy). Also, the potential energy of electrons, which can be converted to mechanical work with almost 100% efficiency, is often confused with the calorific value of a fuel. Take, for example, the following statement: “Burn 3 kcal of coal to get 1 kcal of electricity. “Net energy” is negative 235%, but electricity is higher quality than coal.” (Dr. BRUCE DALE’s presentations at the National Press Club in Washington D.C., Aug. 23, 2005, and at the Ag Biotech & Midwest Rural Development Conference, Chicago, Sep. 8, 2005).

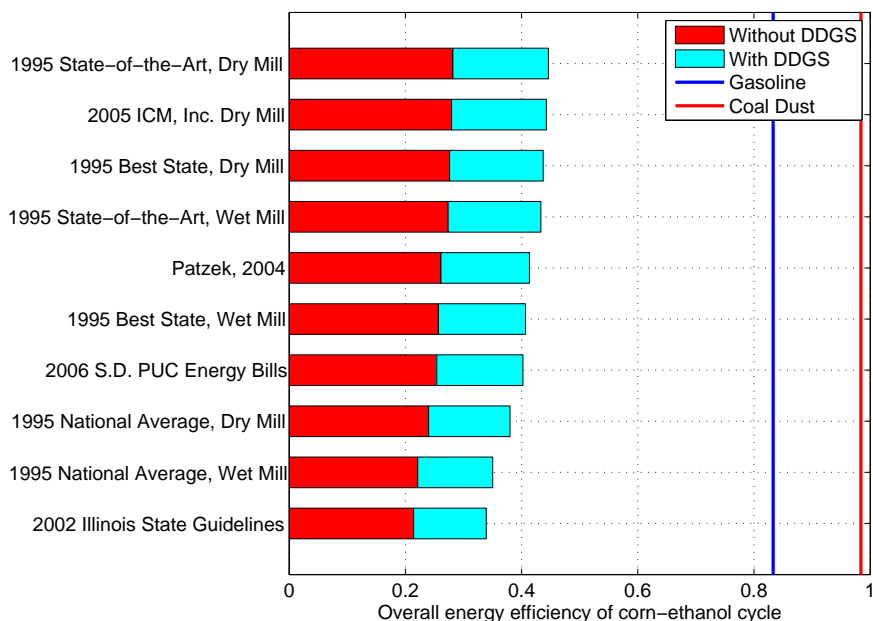

Figure 18: Overall energy efficiency of the industrial corn-ethanol cycle. Data sources are listed in the caption of Figure 14.

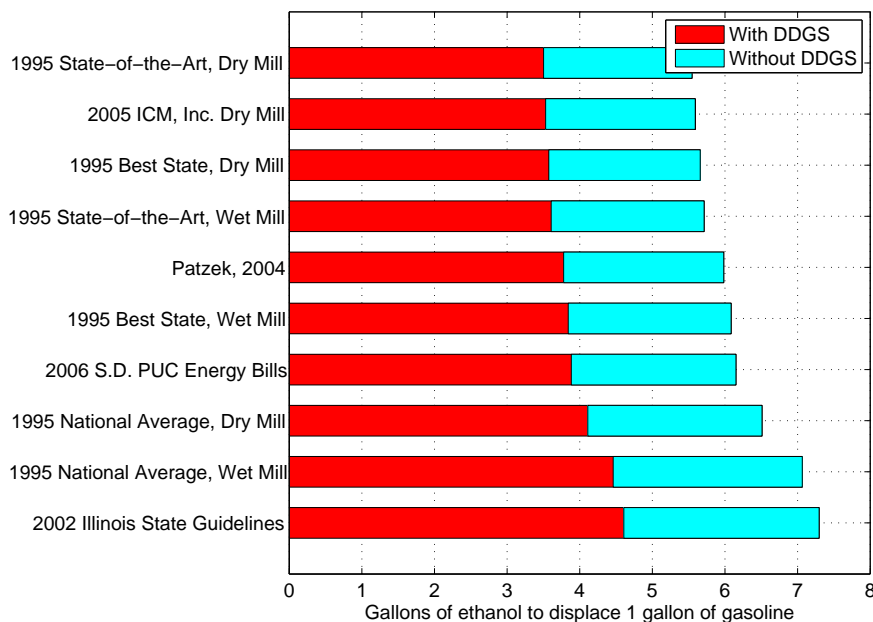

Figure 19: Gallons of ethanol, produced in a cycle driven by corn ethanol, needed to displace energy in 1 gallon of gasoline are calculated as  $1/\eta_1/0.64$  or  $1/\eta_2/0.64$ . With the full DDGS energy credit, 3.9 gallons of ethanol displace on average the energy in 1 gallon of gasoline. Without the DDGS energy credit, this average number is 6.2 gallons of EtOH. Note that the 2006 South Dakota plant represents both averages.

## 5.5 Coproduct Energy Credit Revisited

As highlighted in Footnote 28, there are serious disagreements whether the coproduct energy credits are justified or not. The reasons for their introduction and my arguments against them have been

discussed in Section 4. Now we are ready to make more quantitative arguments:

1. From a pure energy argument, see Eq. (20), the energy embodied in a *fuel* made of bone-dry DDGS is 136/406 or 33% of the energy embodied in corn grain, while the ethanol energy is 233/406 or 57%.
2. The *additional* refinery fossil energy inputs embodied in DDGS are  $0.33 \times 233/136$  or 0.57 of the DDGS energy. The direct fossil energy embodied in harvested corn grain is about 0.2, see Eq. (16). Therefore, 1 bushel of DDGS is equivalent to 3 bushels of corn in terms of its fossil energy content. One might give DDGS an energy credit, but only if one eliminates corn farming in proportion to the ratio of the respective energy contents. Thus, for 4 billion gallons of ethanol per year one would have to eliminate  $0.95 \times 4 \times 10^9 / 2.5 \times 0.33 \times 3 = 1.6$  billion bushes of corn per year, or about 3.5-4 million hectares of farms that produce corn for feed. Otherwise, talk about DDGS “displacing” corn is meaningless.
3. When one performs a mass balance of soil, Eq. (9), as was done in (Patzek, 2004), one discovers that to keep the soil from deterioration and ever-deepening dependence on synthetic fertilizers it is necessary to recycle as much plant matter as possible<sup>35</sup>. This was the thermodynamic reason for my rejection of these credits. No soil mass balance was done in the Report and the references listed in C4.
4. I have argued that DDGS should be returned back to the fields to limit the irreversibility of modern agriculture (see Section 3.12 in (Patzek, 2004)). Therefore, from my macro-ecological point of view, the DDGS energy credit is somewhat *negative*: The DDGS energy *output* of a biorefinery becomes an energy *input* to remote corn farms, minus the energy losses for processing, handling, transport, and spreading the DDGS on the fields. On the other hand, the diminished need for nitrogen fertilizer, decrease of soil erosion, and decrease of toxic water runoff from the fields, will improve energy efficiency of corn agriculture and subtract perhaps as much as 0.2 from the denominator of Eq. (16).
5. From the micro-economic point of view, one could argue that there is monetary value of the co-products replacing corn. In other words, someone operating a corn ethanol distillery could sell these products to offset the cost of corn and fossil energy he/she purchased. The sale price of DDGS could then be translated back into a payment for *some* of the DDGS’ embodied energy. The extent of this reimbursement would depend on the fossil fuel and electricity prices, and DDGS price, and would *not*, in general, be equal to 33% of the grain energy.
6. Dr. MARVIN PAUL SCOTT follows up on this argument<sup>36</sup>, and says: “Inclusion of co-products in the calculation makes a big difference in the outcome, and I find your suggestion that the co-products should be returned to the field intriguing. Have there been any studies of the effects of doing this? It would be an interesting experiment. It may reduce the amount of chemical fertilizers required, in which case it would still have an effect on the calculations. The co-products question ties into problems associated with our food production/consumption system as well. Producing cattle on range and pastureland that is not suitable for row crops is a good use of our resources. Unfortunately, much of our beef is produced in feed lots with feed that includes corn and ethanol co-products and antibiotics to keep [the cattle] healthy. The use of antibiotics in agriculture is a big problem and leads to the development of antibiotic

---

<sup>35</sup>The same argument applies with force to all large-scale schemes to cellulosic ethanol production, see Section 8 and (Patzek and Pimentel, 2006).

<sup>36</sup>Personal communication, Feb. 13, 2006.

resistant strains of bacteria. Handling animal waste from these intensive animal production operations is a big problem as well. Thus, in addition to our demand for energy, our demand for meat is getting us in trouble. It can therefore be argued that the use of ethanol co-products for animal feed is supporting undesirable food production strategies. I think that there are good uses for ethanol co-products (returning them to the field may be one, we do not really know yet) and these uses should be credited to calculations of the desirability of ethanol production from grain.”

7. Following Dr. SCOTT’s argument to its logical conclusion, one might attempt to charge cows fed with DDGS with some or all methane emissions they cause. A single cow burps ~600 L of methane per day (Kaharabata et al., 2000). Assuming a 100-year time horizon, the greenhouse gas emissions from a cow are equivalent to 3 tonnes of CO<sub>2</sub> per year, an amount that would be generated by burning 1.9 tonnes (522 gal) of ethanol per year by a driver who consumes 12 gallons of E85 per week. For a 20-year time horizon, the equivalent CO<sub>2</sub> emissions from methane will be 2.7 times larger (Anonymous, 2002b).

## 6 Equivalent CO<sub>2</sub> Emissions from the Corn-Ethanol Cycle

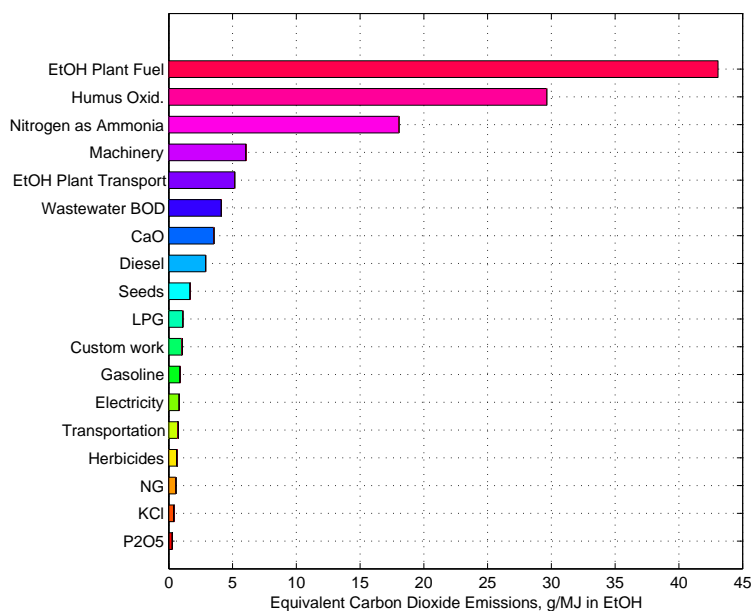

Figure 20: Equivalent CO<sub>2</sub> emissions from each major non-renewable resource consumed by the industrial corn-EtOH cycle.

My methodology for obtaining equivalent<sup>37</sup> CO<sub>2</sub> emissions from the industrial corn ethanol cycle is described in Section 5.1 of (Patzek, 2004). There are three differences between that analysis and the current one:

1. Ammonium nitrate fertilizer is replaced with anhydrous ammonia and the respective emissions are decreased by 1/2.

<sup>37</sup>Emissions of other gases, mostly nitrous oxide N<sub>2</sub>O, ammonia NH<sub>3</sub>, and methane CH<sub>4</sub>, are converted to equivalent CO<sub>2</sub> emissions using their relative potencies in creating the greenhouse effect (Anonymous, 2002b).

2. Emissions from humus oxidation in soil eroded by wind are included with the following assumptions: (a) topsoil contains 4% of humus (Stevenson, 1982), (b) humus contains 50% of C by weight (Stevenson, 1982), wind-eroded soil is enriched in humus by  $(1.3 + 5)/2 \approx 3$  on average (Allison, 1973), (c) wind erodes only 1 mm of topsoil per year, or 10 tonnes/ha-yr (Pimentel, 2006), and (d) the airborne humus is completely oxidized.
3. To make the comparisons meaningful, methane, gasoline, and diesel fuel are now charged with incremental 17% (2% more than before) emissions for their recovery, transportation, and processing.

With these assumptions, the specific emissions of equivalent CO<sub>2</sub> in grams per MJ in ethanol are shown in **Figure 20**. Note that the minimal CO<sub>2</sub> emissions from soil erosion are the second biggest source after ethanol refineries. These soil emissions are likely to be several times higher on flat terrain with dry topsoil, such as that in South Dakota during drought.

The specific emissions from Subsystems I and II in the corn ethanol cycle are compared in **Figure 21** with the equivalent emissions from other fossil fuels, methane, gasoline, and diesel fuel. It seems that the cumulative corn-ethanol emissions are 50% higher than those from ancient fossil fuels.

If one charges corn ethanol with equivalent CO<sub>2</sub> emissions from methane burped by the cows fed with DDGS, one adds at the minimum

$$0.33 \frac{\text{kg DDGS}}{\text{kg dry corn}} \times \frac{1 \text{ kg dry corn}}{0.364 \text{ kg EtOH}} \times \frac{44 \text{ kg CO}_2}{30 \text{ kg DDGS}} \times \frac{0.12 \times 16}{44} \frac{\text{kg CH}_4}{\text{kg CO}_2 \text{ burped}} \times \times 56 \frac{\text{kg equiv. CO}_2}{\text{kg equiv. CH}_4} \times \frac{1 \text{ kg EtOH}}{29.7 \text{ MJ}} \times 1000 \approx 110 \frac{\text{g equiv. CO}_2}{\text{MJ in EtOH}} \quad (28)$$

or another 38% of equivalent CO<sub>2</sub> emissions over and above the gasoline emissions. The factor of 56 in the equation above comes from the relative potency of methane over the 20-year time horizon (Anonymous, 2002b), and it was assumed that 12% of the gas burped by a cow is methane (Kaharabata et al., 2000).

If ethanol refineries switch from natural gas to coal, their GHG emissions will increase by at least 70 – 80%, see Table 19 in (Patzek, 2004), not counting the high energy costs of coal transport to the dispersed biorefineries.

## 7 Ecology & Macro-Economics of Corn Ethanol Production

Let me remind the reader that the U.S. corn is the single largest crop on the earth (the sugarcane crop is larger, but it contains more water). The U.S. produces some 42% of world's corn, see (Patzek, 2004). In 2004, U.S. corn could have fed the entire population of China for one year. A mere 2% of the corn used by the United States goes directly to feed people; another 19 percent goes into processed foods (e.g., high-fructose corn syrup, chips). *Seventy five* percent of U.S. corn goes to feed livestock (Kimbrell, 2003). So ethanol manufacturing coproducts will flood the animal feed market and depress corn price even more.

### 7.1 Ecological Consequences

People who fill their cars with biofuels often think that they are saving the world from an ecological disaster. Unfortunately, on a large scale, the opposite is true (Patzek, 2004; Patzek and Pimentel, 2006),

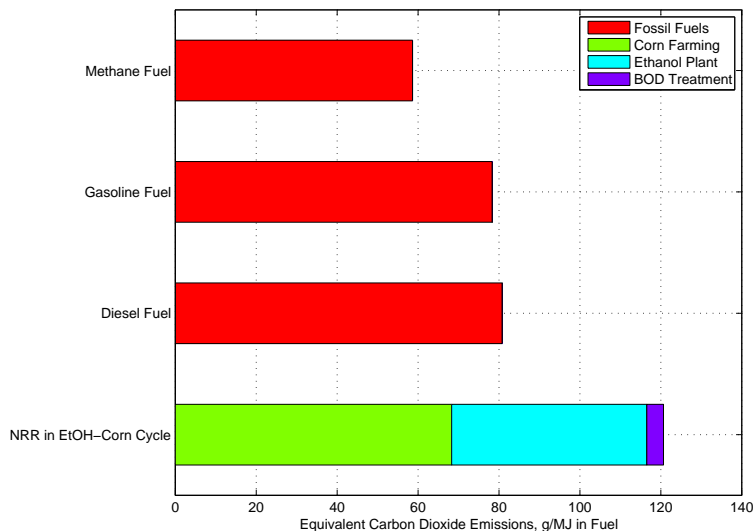

Figure 21: Equivalent CO<sub>2</sub> emissions from corn agriculture, corn ethanol production, and other fossil fuels. The corn-ethanol cycle emissions *double* if methane burped by cows fed with the DDGS coproduct is accounted for.

By now, on average, 1/2 of the top 14 inches of soil in Iowa is gone (Pimentel et al., 1995). Erosion is rampant, see **Figure 7.1**, and so is chemical pollution of the entire Mississippi River drainage basin and the Gulf of Mexico near the Mississippi delta (Scavia et al., 2003), see **Figure 23**. For example, over the last 20 years, the nitrate runoff from the Midwest corn and wheat fields discharged between 2,000 and 10,000 tonnes of nitrate *per day* into the Gulf of Mexico. Thus, thanks to agribusiness and industrial agriculture, the most productive grassland ecosystem on the earth may be destroyed in another 70 years. As they continue to be degraded, Midwestern fields will have to become larger and be subsidized even more with fossil energy (Ho and Ulanowicz, 2005).

Industrial crop production (corn, wheat, soybeans, etc.) causes environmental damage and lost human health valued at between \$5.7 and \$16.9 billion per year (Tegtmeier and Duffy, 2004). The hidden subsidies of agribusiness from the environmental resources are estimated to be \$24–96/ha-yr.

If one compares a corn field with a prairie, one concludes that the prairie runs on sunlight<sup>38</sup>, while the corn field runs on fossil fuels (Kimbrell, 2002), p. 101. The most eloquent testimony to this effect was given by Ms. THERESA SCHMALSHOF of the National Corn Growers Association (NCGA) before the House Subcommittee on Energy and Mineral Resources, Washington, D.C., May 19, 2005. Ms. SCHMALSHOF was strongly in favor of getting more natural gas and oil from anywhere in the U.S., including the Arctic National Wildlife Reserve (ANWR) and the outer continental shelf, to provide more of the vital fossil fuels for the corn and ethanol industries. She also wanted us to use much more coal in ethanol plants to displace the increasingly expensive natural gas<sup>39</sup>.

I have not addressed here the looming shortage of all water in the U.S. (Gale, 2006). We will run out of clean water for drinking, agriculture, ethanol processing, and other industrial uses a

<sup>38</sup>The cellulosic ethanol proponents confuse the high ecological *efficiency* of a grassland system (almost 100%) that recycles practically all mass, with its *net productivity*, which is almost exactly zero (Ulanowicz and Hannon, 1987; Patzek and Pimentel, 2006; Ho and Ulanowicz, 2005).

<sup>39</sup>Ms. SCHMALSHOF's testimony is available at <http://resourcescommittee.house.gov/archives/109/testimony/-2005/TheresaSchmalshof.htm>



Figure 22: The Root River drains two SE Minnesota counties (Fillmore and Houston) and discharges its deep-brown waters to the Mississippi River. Top soil runoff from corn/soybean crop rotation fields after a 2" rain. This aerial photograph was taken mid-July, 2005, by the University of Minnesota. Source: Private communication, Mr. JEFF WEBSTER, who lives in that neighborhood, Nov. 9, 2005.

long time before we run out of coal or tight-rock natural gas. Here is just one example posted<sup>40</sup> on the Web: "My company is currently suspending drilling operations in Oklahoma due to lack of available water. State, municipal and private water owners have all told us that they will no longer sell water to us. We are experiencing similar problems in Colorado, Wyoming and New Mexico, but not to the degree we have encountered in Oklahoma."

## 7.2 Economic Consequences for Midwest

What are the economic consequences of producing excessive quantities of an undifferentiated commodity, industrial corn? A quantitative answer for the largest corn producer, Iowa, is shown in **Figure 24**. In constant dollars the price of corn in Iowa has declined 10-fold between 1947 and 2005. The corn yields in Iowa have increased only 3-fold in the same time frame. Today's Iowa farmers earn 1/3 of they did in 1947 selling corn, while their production costs have increased many-fold, because they essentially burn methane, coal, and diesel fuel to produce corn<sup>41</sup>. The price of methane has increased several-fold in the last three years<sup>42</sup>. Corn crop subsidies supplemented the market corn price by up to 50 percent between 1995 and 2004.

The consequences of reverse trends in corn production costs and corn price in Iowa are inescapable. There will be even more concentration of industrial corn production in giga-farms

<sup>40</sup>Source: Mr. NATHAN J. HAGENS, Private communication, Feb. 22, 2006.

<sup>41</sup>Mr. ARNO BOMMER has called these activities "fossil-fuel laundering." Private communication, Feb. 17, 2006.

<sup>42</sup>"High costs for fertilizer, fuel and irrigation are expected to take a heavy toll on Kansas farmers next year, with agricultural economists projecting net incomes to plummet nearly 37 percent from 2004 for dryland farms across the state. The forecast is even more grim for irrigated crop farms, where high energy costs to pump water are expected to cut net farm incomes by nearly 91 percent in 2006, a study shows." Source: ROXANA HEGEMAN, AP, *High fuel costs projected to slash farm incomes*, Posted on Fri, Nov. 25, 2005, [www.kansas.com/mld/kansas/news/state/-13257576.htm](http://www.kansas.com/mld/kansas/news/state/-13257576.htm)

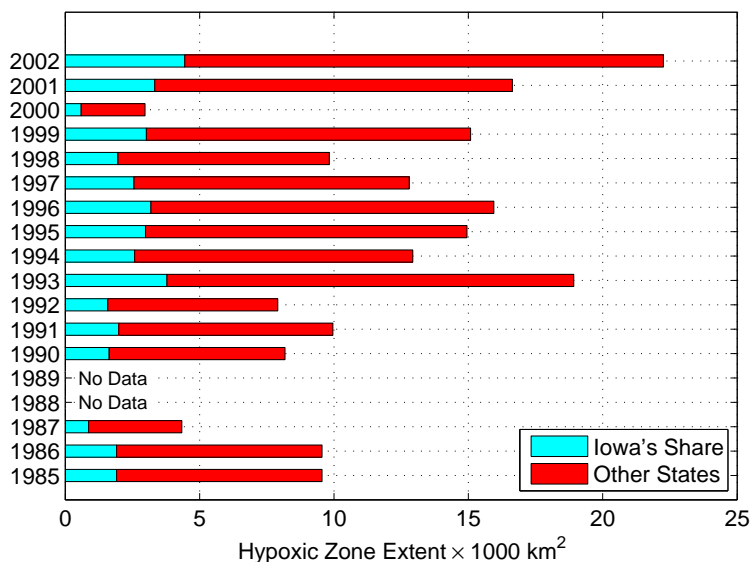

Figure 23: The run-off agricultural chemicals (nitrates, phosphates, potassium, calcium, etc.) discharge into the Gulf of Mexico and cause a large anoxic zone there. This zone seems to have appeared in the early 1980's. Source: (Scavia *et al.*, 2003).

operated by large agribusiness corporations, and real farmers will only rent the land.

In words of Dr. KAMYAR ENSHAYAN<sup>43</sup>:

Economist KEN METER has assembled data from Agricultural Census and the Bureau of Economic Analysis for many counties around the nation to characterize the nature of commodity agriculture (Meter, 2005). For our 8-county area around Black Hawk County, we have about 8,500 farmers who mostly raise corn and beans and some livestock. On the average, from 1999 to 2003, these farms sold \$1.08 billion worth of crops every year. But, they spent \$1.14 billion every year to produce it. A loss of \$62 million, every year, from 1999-2003. Most other counties in Iowa are doing worse, even as we see images of record harvest, etc.

During the same period, our 8-county area farms received \$173 million per year in federal government crop subsidies for corn and beans. It is a long story, but by every measure rural communities are declining and these huge subsidies have not helped, because these are not community-building subsidies, these are commodity-exporting subsidies for two specific crops.

### 7.3 Economic Consequences for U.S.

American taxpayers spent a staggering \$143.8 billion on farm subsidies over the past ten years, more than \$104 billion of which (72 percent) went to the top 10 percent of recipients—some 312,000 large farming operations, cooperatives, partnerships and corporations that collected, on average, more than \$33,000 every year. Most of this money goes to support the prices of just three commodities: corn, soybeans and wheat. Only a small fraction is spent on conservation and restoration programs.

<sup>43</sup>Dr. KAMYAR ENSHAYAN is an agricultural engineer and works at University of Northern Iowa. He can be reached at [Kamyar.enshayan@uni.edu](mailto:Kamyar.enshayan@uni.edu). His report is posted at [www.uni.edu/ceee/foodproject](http://www.uni.edu/ceee/foodproject).



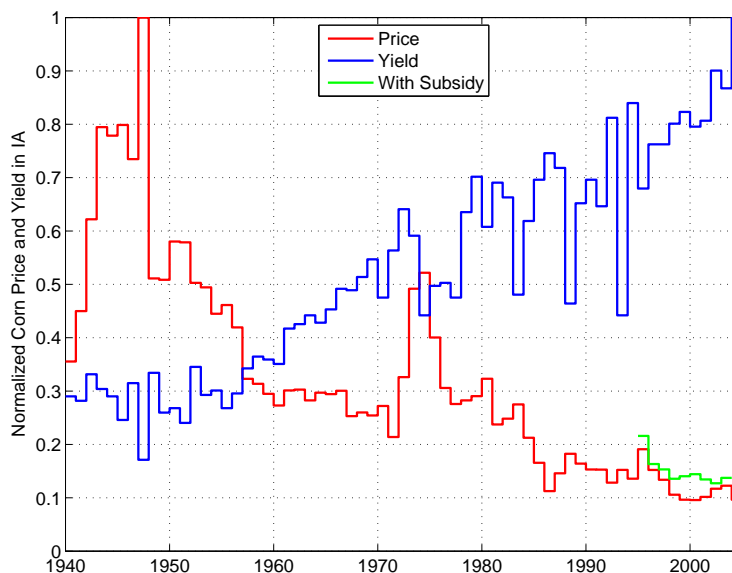

Figure 24: The normalized corn yields and constant-dollars corn price in Iowa over the last 60 years. Note that since 1947 the real price of corn has decreased 10-fold while its yield increased 3-fold. At times, 50% of corn price has come from corn crop subsidies by USDA. Sources: Corn yield and prices, USDA NASS and U.S. Department of Treasury; corn subsidies, Environmental Working Group, [www.ewg.org](http://www.ewg.org).

For example, in Iowa only 14.6% of farm subsidies were spent on conservation and restoration of the environment, see Footnote 29.

As long as agribusiness receives billions of dollars each year in corn-price subsidies, it obtains a significant gift from the taxpayers: An industrial raw material (corn grain) at rock-bottom price, which can be processed into, say, ethanol at a significant profit. This profit is further enhanced by a subsidy of 51 cents per gallon of ethanol, another courtesy of the taxpayers via the Federal Volumetric Ethanol Excise Tax Credit (VEETC) and the “Small Producers” ethanol tax credit of 10 cents of gallon. But it does not end there. States and local communities lavish further subsidies and ethanol producers, thus forgoing their own sources of tax income.

The direct taxpayer subsidies of corn agriculture and corn ethanol, and the unbiased energy-equivalent cost of this ethanol are listed in **Table 6**. The indirect taxpayer subsidies of “free” exploitation of the environment are not included.

A case of ethanol pricing subsidy is illustrated in **Figure 25**. As noted in Footnote 5, distance driven by a properly tuned car is directly proportional to the calorific value of the car’s fuel. Ethanol has 64 percent of the Low Heating Value of gasoline, see Table 5. What does it mean?

In terms of driving distance, 1 gallon of E85 is equivalent to  $0.85 \times 0.95 \times 0.64 + (0.15 + 0.85 \times 0.05) \times 1 = 0.709$  gallons of unleaded gasoline. If one prices ordinary unleaded gasoline at \$2.52/gallon and E85 at \$2.22/gallon, as in Figure 25, the customer thinks that he/she gets a better deal. However, the energy-equivalent price of 1 gallon of E85 is  $\$2.22/0.709 = \$3.13$ . So, in fact, the buyer of E85 gasoline priced in Figure 25 subsidizes the ethanol seller with  $\$3.13 - \$2.22 = \$0.91$  per gallon of E85. By using 20 gallons of E85 per week, a driver will spend an additional \$1000 per year. The understated<sup>44</sup> differential costs of driving flexible fuel vehicles (FFV) can be obtained from the National Energy Technology Laboratory website [www.fueleconomy.gov/feg/byfueltype.htm](http://www.fueleconomy.gov/feg/byfueltype.htm).

<sup>44</sup>For real-life driving, the EPA mileage estimates may be too high by as much as 40–50%.

Finally, ethanol dissolves a large number of substances insoluble in water and acids, such as many inorganic salts, phosphorus, sulphur, iodine, resins, essential oils, fats, coloring matters, etc. (Wright, 1994). Therefore, the metal-rich sludge in fuel tanks of most older cars will dissolve in ethanol-containing gasoline and accelerate corrosion of fuel systems and engines in these cars. Older fiberglass fuel tanks will dissolve in ethanol concentrated in the omnipresent trace water, causing gradual failure of many motor boat engines. Because fuel tanks in gas stations are made of steel, there will be increased corrosion from the metal salts-ethanol-water electrolyte. This corrosion will ultimately eat through the tank walls.

According to NREL (Anonymous, 2002a), nonmetallic materials that degrade when in contact with fuel ethanol include natural rubber, polyurethane, cork gasket material, leather, polyvinyl chloride (PVC), polyamides, methyl-methacrylate plastics, and certain thermo- and thermoset plastics. Metallic materials that degrade in contact with ethanol include zinc, brass, lead, and aluminum. Terne (lead-tin-alloy)-plated steel, which is commonly used for gasoline fuel tanks, and lead-based solder are also incompatible with ethanol.

Table 6: True cost of corn ethanol to taxpayers

Line	Fact	Value	Units
1	2005 EtOH production capacity <sup>a</sup>	4486	10 <sup>6</sup> gallons denatured per year
2	“Small producers” <sup>b</sup> EtOH capacity	2597	10 <sup>6</sup> gallons denatured per year
3	Mean ethanol tax credit <sup>c</sup> for “small producers”	0.0579	\$/gallon denatured
4	VEETC tax credit <sup>d</sup>	0.5100	\$/gallon denatured
5	Mean ethanol tax credits	0.5679	\$/gallon denatured
6	Cumulative corn subsidies <sup>e</sup> in US from 1995 to 2004	41.90	\$ Billion
7	Cumulative corn produced <sup>f</sup> in US from 1995 to 2004	95.309	Billion Bushels
8	Average <sup>g</sup> corn subsidies from 1995 to 2004	0.4396	\$/bushel
9	Mean rack price <sup>h</sup> of EtOH (06/19/06)	3.6472	\$/gallon denatured
10	Mean EtOH yield <sup>i</sup> from 2000 to 2004	2.4776	gallons EtOH/bushel
11	Mean subsidy <sup>j</sup> of EtOH from corn subsidies	0.1774	\$/gallon EtOH
12	Mean state subsidies <sup>k</sup> for EtOH	0.1535	\$/gallon EtOH denatured
13	Total mean subsidy <sup>l</sup> of EtOH	0.8988	\$/gallon EtOH denatured
14	<b>Mean cost<sup>m</sup> of EtOH to taxpayer</b>	<b>4.5461</b>	<b>\$/gallon EtOH denatured</b>
15	Mean premium gasoline price <sup>n</sup>	3.1700	\$/gallon
16	<b>Energy equivalent<sup>o</sup> cost of EtOH to taxpayer</b>	<b>6.9089</b>	<b>\$/gallon GGE</b>

<sup>a</sup> <http://www.ethanolrfa.org/industry/locations/>, updated 04/12/06

<sup>b</sup> As in *a*. A “small-producers” tax credit of \$0.10/gallon for the producers of up to 60 million gallons EtOH per year  
<sup>c</sup> Line 2/1 × 0.10

<sup>d</sup> The Federal Volumetric Ethanol Excise Tax Credit, [http://www.irs.gov/irb/2005-02\\_IRB/ar14.html](http://www.irs.gov/irb/2005-02_IRB/ar14.html)

<sup>e</sup> <http://www.ewg.org/farm/region.php?fips=00000>, accessed 4/14/06

<sup>f</sup> <http://www.ers.usda.gov/Briefing/Corn/>, accessed 04/14/06

<sup>g</sup> Line 6/7

<sup>h</sup> <http://www.axxispetro.com/ace.shtml>. The mean rack price in the largest ethanol producing states in the Midwest. The rack price of ethanol delivered to both coasts will be at least \$0.15 higher because of transportation costs

<sup>i</sup> The mean of (Industry-reported yields - Brazilian imports), multiplied by 0.95 to remove gasoline denaturant

<sup>j</sup> Line 8/10

<sup>k</sup> Source: <http://www.opisnet.com/headlines.asp>, *Sunny Forecast for Summer Ethanol Blending*, accessed 02/21/05

<sup>l</sup> Lines 5 + 11 + 12

<sup>m</sup> Lines 9 + 13

<sup>n</sup> DOE Energy Information Administration

<sup>o</sup> Direct cost, excluding environment subsidies. Line 14/(0.95 × 0.64 + 0.05). GGE = Gallon Gasoline Equivalent



Figure 25: The caption of this photograph was: “At this station in Chicago last month, E85 was clearly the fuel of choice for consumers trying to save money or reduce oil imports.”. Source: SIMON ROMERO, *Much Talk, Little Action on Energy Front*, The New York Times, Feb. 2, 2006, Pages C1-C4.

## 8 Cellulosic Ethanol

The discussion of cellulosic ethanol in the Report has been limited to one point per Fig. 1 and 2, and a couple of sentences that describe the current lack of data and analyses. The authors, nevertheless, predict that cellulosic ethanol will play a key role in meeting “the nation’s energy and environmental goals.”

It is difficult to cope with an argument that has not been presented yet, but a couple of comments are in order. First, the term “cellulosic ethanol” is imprecise. It is meant to suggest that certain components of wood and green plant materials (cellulose, pectins, and hemicelluloses) can be chemically separated (from mostly lignin in wood) and partially split into hexose and pentose monomers, which are then fermented to produce ethanol.

Cellulose is the principal structural component of cell walls in higher plants. It is the most abundant form of living terrestrial biomass (Crawford, 1981). For hundreds of millions of years, cellulose has protected plants from elements and animals, and from chemical attacks by fungi and bacteria. Cotton is 98% pure cellulose; flax is 80%, and wood is 40-50% cellulose, with the remaining 50-60% made up from other complex polysaccharides (20-35% hemicellulose and 15-35% lignin).

The special properties of cellulose result from the association of the long, straight polymeric chains to form fibers called micro-fibrils. The micro-fibrils then form larger fibers, which are laid down in a criss-cross pattern, and intermixed with gel-like polysaccharides, hemicelluloses and pectins, that function as biocement (Taiz and Zeiger, 1998). In some ways this structure resembles fiberglass and other composite materials, in which rigid crystalline fibers are used to reinforce a more flexible matrix.

The beta-glycosidic bonds are crucial in determining the structural properties of cellulose, and thus the strength of the cellulose fibers. Because of the beta-bonds, the chain assumes an extended rigid configuration, with each glucose residue turned 180 deg from its neighbor, see (Taiz and Zeiger, 1998), Chapter 15. Another consequence of alternating top/bottom glucose residues is that OH groups of adjacent chains allow very extensive hydrogen-bonding between chains. This extensive inter-chain hydrogen-bonding, and rigid beta-configuration makes cellulose fibers very strong and able to resist strong sodium hydroxide and acid solutions.

**Remark 17** Close to one billion years of plant evolution have made cellulose very stable and resistant to biochemical attacks. Cellulose can be quickly decomposed and hydrolyzed only by mechanical grinding or steam exploding and severe chemical attack by hot concentrated sulfuric

acid or sodium hydroxide. Biochemical enzymatic attacks take a long time and have low efficiency.□

The process of separating cellulose fibers from the rest of woody biomass is well-known, fast, efficient, and very energy intensive. It is called the paper kraft-process<sup>45</sup>. Unfortunately, the best energy efficiency of this process is  $\sim 30$  MJ/kg of paper pulp<sup>46</sup>, more than the high heating value of pure ethanol. Therefore a much milder, enzymatic process must be used to obtain simple sugars from cellulose.

Here is a brief summary of the formidable obstacles faced by cellulosic ethanol:

**Contamination:** For corn starch fuel ethanol, normal fermentation times in batch mode (there are no continuous reactors in operation) are 48 hours; up to 72 hours is acceptable, see Section 3.2. These estimates do not include downtime, cleaning, start up, etc. Over 72 hours the number of failures increases exponentially due to contamination with bacteria: acetogens and others, see Figure 26 and Footnote 14. As described in the literature, typical enzyme processes for lignocellulosic alcohol take 5 to 7 days, i.e., about 120-170 hours. This spells big problems if lignocellulosic ethanol producers ever go outside the laboratory or pilot scale (sterile fermenters) to a conventional fermentation vessel, which can *not* be sterilized for 120–170 hours.

**Biomass availability:** Natural productivity of a mature ecosystem (an earth household, e.g., a forest or grassland) is practically *zero* on human time scale<sup>47</sup>. What is produced by autotrophic plants and algae, and by rock weathering and floods, is consumed by heterotrophs (bacteria, fungi, and animals that are continuously recycled as nutrients for the plants). Therefore, “biowaste” is an engineering classification of plant (and animal) parts unused in an industrial process. This dated human *concept* is completely alien to natural ecosystems, which must recycle their matter *completely* in order to survive. Excessive “biowaste” removal robs ecosystems of vital nutrients and species, and degrades them irreversibly. As discussed in (Patzek and Pimentel, 2006), those ecosystems from which we remove biomass at high rate (crop fields, tree plantations) must be heavily subsidized with fossil energy and earth minerals (see THERESA SCHMALSHOF’s testimony, Footnote 39).

**Enzyme Yield vs. Rate:** The rate of lignocellulose hydrolysis and fermentation can be increased by enough pre-treatment (such as ball milling to exceedingly fine dust, at enormous energy costs, or steam exploding with acid pre-treatment), but rates will slow down rather rapidly before high yields are obtained. The main problem is the number of binding sites available; the outside-in rate limitation phenomenon. It simply takes time to chew into the sturdy lignocellulosic particles. Of course, one *could* run the lignocellulose through the kraft-like process. This cannot be done, however, for lignocellulosic ethanol because energy losses would be severe. One can get rather good yields and rates if one performs energy-intensive and unaffordable pretreatment, or (relatively) high yields with modest pre-treatment if one waits long enough (ideally for weeks). Thus, despite claims to the contrary, a real industrial process for lignocellulosic ethanol does not exist, and may *never* have a sufficiently favorable energy balance.

---

<sup>45</sup>The kraft process is used in production of paper pulp and involves the use of caustic sodium hydroxide and sodium sulfide to extract the lignin from the wood fiber in large pressure vessels called digesters. The process name is derived from German kraft, meaning strong. It was developed by CARL DAHL in 1884 and now is used for about 80% of production volume of paper. Source: Wikipedia.

<sup>46</sup>See Professor ROBERT U. AYRES’ lecture in Barcelona, Spain, antalya.uab.es/~c-ceambientals/XTEI/curs/-Ayres2.pdf

<sup>47</sup>Very slow carbon burial occurs on geological time scale.

**Thermodynamics:** Current energy efficiency of producing cellulosic ethanol is so low that *all* other investigated paths to liquid biofuels are better, see (Patzek and Pimentel, 2006).

**Better Solutions:** There is a better way of converting *any* biomass to synthetic fuels other than ethanol. It is called the FISCHER-TROPSCH process, and it was discussed in detail in (Patzek and Pimentel, 2006).

## 9 Summary and Conclusions

This paper has been written in response to the Science Report by FARRELL *et al.* (2006a; 2006c) and the related gray-literature reports (Wang, 2001; Graboski, 2002; Shapouri *et al.*, 2002; Shapouri and McAloon, 2004).

It has been shown here that the mass and energy calculations in (Farrell *et al.*, 2006a) and, by extension, in (Wang *et al.*, 1997; Wang, 2001; Shapouri *et al.*, 2002; Shapouri *et al.*, 2003; Shapouri and McAloon, 2004), violate the fundamental laws of mass and energy conservation. In particular, Eq. (S-2) in (Farrell *et al.*, 2006c), generates ethanol coproduct energy from nothing. This energy could then be used to drive a CARNOT engine (Carnot, 1943), in direct contradiction to the First Law of thermodynamics. In effect, (Farrell *et al.*, 2006a) have constructed a perpetuum mobile of the first kind (Hatsopoloulos and Keenan, 1965).

The energy cost of producing and refining carbon fuels in real time, e.g., corn and ethanol, is very high relative to that of fossil fuels deposited and concentrated over geological time. Proper mass and energy balances of corn fields and ethanol refineries that account for photosynthetic energy, some of the environment restoration work, and the coproduct energy have been formulated. These balances show that production of ethanol from corn is 2 – 4 times less favorable than production of gasoline from petroleum. Also, for thermodynamical reasons, ecological devastation wrought by the real-time industrial biofuel production *must* be severe.

The main conclusion of this paper is that the United States has already spent enough time, money, and natural and human resources on pursuing the mirage of *replacing* fossil fuels in aggregate (petroleum + natural gas + coal) with biomass. Better solutions lie on the demand side: limiting consumption, improving efficiency, consuming more locally, fostering local biofuel production, etc. These solutions are feasible, readily available, and usually ignored.

My thorough critique of cellulosic ethanol schemes will be delivered elsewhere. Here it suffices to say that (i) the astronomic quantities of cellulosic biomass will never be extractable from ecosystems without commensurate fossil fuel subsidies and (ii) the production of cellulosic ethanol from wood is always the poorest energy conversion option in tropical biomass plantations. For a detailed thermodynamic analysis of biomass conversion to energy, including cellulosic ethanol, please see PATZEK & PIMENTEL (2006).

Finally, I believe we need to move the public discussion away from simplistic debate whether biofuels are good or bad to the more realistic question: At what level should we be producing biofuels? I do not think it is zero. Today biofuels replace a very small fraction of transportation fuels and, unless we are successful in developing cellulose-based fuels (obviously feedstock, environmental and land use issues have to be addressed here too), this fraction will remain small.

*Build to-day, then, strong and sure,  
With a firm and ample base;  
And ascending and secure  
Shall to-morrow find its place.*

The Builders by HENRY WADSWORTH LONGFELLOW

## 10 Acknowledgements

My work on biofuels receives zero funding. I have received, however, heart-felt support from hundreds of people of different walks of life: students at Berkeley, Iowa State and many other campuses, farmers, engineers, community activists, environmentalists, lawyers, scientists, academic teachers, business people, consultants, writers, journalists, and so on. I cannot overstate how much their encouragement has meant to me and I thank them all from the bottom of my heart. In particular, I would like to thank my wife, Joanna, for putting up with my being absent almost every evening and weekend for five weeks. I want to thank Ms. Katie Schwartz, a graduate student in my group, for programming in pstricks the beautiful schematics of ethanol plant and pyruvate reaction pathways. Many people have provided me with important information; their personal communications are acknowledged in the footnotes, and I thank them here again. In particular, I would like to thank Dr. DMITRIY SILIN and another person, who wishes to remain anonymous, for their meticulous reviews of the paper manuscript, and significant improvements to its content and style. Dr. CLAYTON RADKE has zeroed in on Section 5 and made me explain the crucial mass and energy balances so much better. Dr. DAVID ANDRESS has provided an insightful written critique of the manuscript, most of which has been incorporated. In addition, Drs. KAMYAR ENSHAYAN, DAVID HIRSHFELD, RICHARD MULLER, DAVID PIMENTEL, and MARVIN SCOTT, and Mr. NATHAN HAGENS, HARRY BLAZER and JEFF WEBSTER reviewed the manuscript and provided valuable feedback. Finally, I am very grateful to my cellular biologist son LUCAS, currently with the Harvard Medical School, and my freshly minted biochemist daughter SOPHIE, for carefully editing the manuscript and providing the final touches.

## References

- Abbott, M. M. and Van Ness, H. C. 1972, *Thermodynamics*, McGraw-Hill Book Company, New York.
- Allison, F. E. 1973, *Soil Organic Matter and Its Role in Crop Production*, Elsevier, New York.
- Anonymous 2002a, *Handbook for Handling, Storing, and Dispensing E85*, National Renewable Energy Laboratory, U.S. Department of Energy: <http://www.nrel.gov/docs/fy02osti/30849.pdf>.
- Anonymous 2002b, *Inventory of U.S. Greenhouse Gas Emissions and Sinks: 1990 - 2000*, Report EPA 430-R-02-003, U.S. Environmental Protection Agency, Office of Atmospheric Programs, Washington, D.C., [http://yosemite.epa.gov/oar/globalwarming.nsf/-UniqueKeyLookup/SHSU5BUM9T/\\$File/ghg\\_gwp.pdf](http://yosemite.epa.gov/oar/globalwarming.nsf/-UniqueKeyLookup/SHSU5BUM9T/$File/ghg_gwp.pdf).
- Anonymous 2003, *Public Health Assessment Gopher State Ethanol, City of St. Paul Ramsey County, Minnesota*, Report Under Cooperative Agreement with the Agency for Toxic Substances and Disease Registry, The Minnesota Department of Health, St. Paul, MN 55164-0975, [www.health.state.mn.us/divs/eh/hazardous/sites/ramsey/gopher/pha.html](http://www.health.state.mn.us/divs/eh/hazardous/sites/ramsey/gopher/pha.html).
- Berger, J. E. 1984, *Encyclopedia of Chemical Processing and Design*, Chapt. 20. Ethanol as Fuel: Options, Advantages, Disadvantages to Exhaust Stacks, Cost, pp 1–11, Marcel Dekker, Inc., New York.
- Berthiaume, R., Bouchard, C., and Rosen, M. A. 2001, Exergetic evaluation of the renewability of a biofuel, *Exergy Int. J.* **1**(4): 256–68.
- Bossel, U. 2003, *Well-to-Wheel Studies, Heating Values, and the Energy Conservation Principle*, Technical report, European Fuel Cell Forum, Morgenacherstrasse 2F, CH-5452 Oberrohrdorf, Switzerland, <http://www.efcf.com>.
- Brinkman, N. D., Gallopoulos, N. E., and Jackson, M. W. 1975, Exhaust emissions, fuel econ-

- omy, and driveability of vehicles fueled with alcohol-gasoline blends, No. 750120, Society of Automotive Engineers.
- Carnot, S. 1943, *Reflections on the Motive Power of Heat and on the Machines Fitted to Develop This Power*, The American Society of Mechanical Engineers, New York.
- Castorph, D., Kollera, M., and Waas, P. 1999, *Brennwert und Heizwert (The High and Low Heating Values)*, Technical report, Fachhochschule München, FB 03, Dachauer Straße 98 b, 80335 München, <http://www.fm.fh-muenchen.de/labore/waas/skripten/kap11.pdf>.
- Crawford, R. L. 1981, *Lignin biodegradation and transformation*, John Wiley and Sons, New York, <http://www.ac.wvu.edu/~stephan/malthus/malthus.0.html>.
- Dawes, I. and Large, P. J. 1982, *Biochemistry and Bacterial Growth*, Chapt. Class 1 reactions: Supply of carbon skeletons, pp 125–158, Blackwell, Oxford.
- de Oliveira, M. E. D., Vaughan, B. E., and Rykiel, E. J. 2005, Ethanol as fuel: Energy, carbon dioxide balances, and ecological footprint, *Bioscience* **55(7)**: 593–602.
- Domalski, E. S., Jobe Jr., T. L., and Milne, T. A. (eds.) 1987, *Thermodynamic Data for Biomass Materials and Waste Components*, The American Society of Mechanical Engineers, United Engineering Center, 345 East 47th Street, New York, N.Y. 10017.
- Eckhoff, S. R., Singh, K., Zehr, B. E., Rausch, K. D., Fox, E. J., Mistry, A. K., Haken, A. E., Niu, Y. X., Zou, S. H., Buriak, P., Tumbleson, M. E., and Keeling, P. L. 1996, A 100g laboratory corn wet milling procedure, *Cereal Chemistry* **73**: 54–57.
- Farrell, A. E., Plevin, R. J., Turner, B. T., Jones, A. D., O’Hare, M., and Kammen, D. M. 2006a, Ethanol can contribute to energy and environmental goals, *Science* **311**: 506–508.
- Farrell, A. E., Plevin, R. J., Turner, B. T., Jones, A. D., O’Hare, M., and Kammen, D. M. 2006b, Science Letters – Response, *Science* **312**: 1747–1748.
- Farrell, A. E., Plevin, R. J., Turner, B. T., Jones, A. D., O’Hare, M., and Kammen, D. M. 2006c, *Supporting Online Material*, [www.sciencemag.org/cgi/content/full/311/5760/506/DC1](http://www.sciencemag.org/cgi/content/full/311/5760/506/DC1).
- Gale, T. 2006, *Turning off the taps; The Great Plains. (The water may run out)*, Article 378.8464, 14 Feb., The Economist (US), Expanded Academic ASAP.
- Gaston, L. L. 1955, *The unity of knowledge*, The Columbia University Bicentennial Conference Series, Doubleday, Garden City, NY.
- Georgescu-Roegen, N. 1971, *The Entropy Law and the Economic Process*, Harvard University Press, Cambridge, Massachusetts.
- Good, N. E. and Bell, D. H. 1980, *The Biology of Crop Productivity*, Chapt. Photosynthesis, Plant Productivity and Crop Yield, pp 3–50, Academic Press, Inc., New York.
- Graboski, M. S. 2002, *Fossil Energy Use in the Manufacture of Corn Ethanol*, Report prepared for the National Corn Growers Association, Colorado School of Mines.
- Hall, C. A. S. and Day, J. W. (eds.) 1977, *Ecosystem Modeling in Theory and Practice: An Introduction with Case Histories*, John Wiley & Sons, New York.
- Hatsopoloulos, G. and Keenan, J. 1965, *Principles of General Thermodynamics*, John Wiley & Sons, New York.
- Ho, M.-W. and Ulanowicz, R. 2005, Sustainable systems as organisms?, *Biosystems* **82**: 39 – 51.
- Howarth, R. W. 2000, Nutrient pollution of coastal rivers, bays, and seas, *Issues in Ecology* **7**.
- Howarth, R. W., Boyer, E. W., Pabich, W. J., and Galloway, J. N. 2002, Nitrogen use in the United States from 1961–2000 and potential future trends, *Ambio* **31(2)**: 88 – 96.
- Joos, D. 2005, *Variety Testing*, Department of Crop Sciences, 2008 South Wright St., Urbana, IL 61801, <http://vt.cropsci.uiuc.edu/corn.html>.
- Kaharabata, S. K., Schuepp, P. H., and Desjardins, R. L. 2000, Estimating methane emissions from dairy cattle housed in a barn and feedlot using an atmospheric tracer, *Environmental Science & Technology* **34(15)**: 3296–3302, <http://dx.doi.org/10.1021/es990578c>.

- Kimbrell, A. (ed.) 2002, *Fatal Harvest: The Tragedy of Industrial Agriculture*, Island Press, Washington.
- Kimbrell, A. (ed.) 2003, *Fatal Harvest: The Tragedy of Industrial Agriculture*, Foundation for Deep Ecology, New York.
- Lemon, E. R. 1960, Photosynthesis under field conditions II. An aerodynamic method for determining the turbulent carbon dioxide exchange between the atmosphere and a corn field, *Agron. J.* **52**: 697–703.
- Lide, D. R. (ed.) 1994, *CRC Handbook of Chemistry and Physics*, CRC Press, Boca Raton, FL, 75 edition.
- Meter, K. 2005, *Black Hawk County (Iowa) Region's Food & Farm Economy*, Web: [www.crcworks.org/blackhawksum.pdf](http://www.crcworks.org/blackhawksum.pdf), Crossroads Resource Center, P.O. Box 7423, Minneapolis, Minnesota 55407, Tel: 612.869.8664.
- Miller, D. F. 1958, *Composition of Cereal Grains and Forages*, National Academy of Sciences – National Research Council, Washington, D. C..
- Morris, D. 2005, *The Carbohydrate Economy, Biofuels and the Net Energy Balance*, Web report, [www.ilsr.org](http://www.ilsr.org), (24 pages), Institute for Local Self-Reliance, Washington, D.C..
- Morris, D. and Ahmed, I. 1992, *How Much Energy Does it take to Make a Gallon of Ethanol?*, Monograph (8 pages), Institute for Local Self-Reliance, Washington, D.C., Updates published at [http://www.carbohydrateeconomy.org/library/admin/uploadedfiles/How\\_Much\\_Energy\\_Does\\_it\\_Take\\_to\\_Make\\_a\\_Gallon\\_.html](http://www.carbohydrateeconomy.org/library/admin/uploadedfiles/How_Much_Energy_Does_it_Take_to_Make_a_Gallon_.html).
- Musgrave, R. B. and Moss, D. N. 1961, Photosynthesis under field conditions I. A portable, closed system for determining net assimilation and transpiration of corn, *Crop Sci.* **1**: 37–41.
- Odum, E. 1998, *Ecological Vignettes – Ecological Approaches to Dealing with Human Predicaments*, Hardwood Academic Publishers, Amsterdam.
- Patzek, T. W. 2004, Thermodynamics of the corn-ethanol biofuel cycle, *Critical Reviews in Plant Sciences* **23(6)**: 519–567, An updated web version is at <http://petroleum.berkeley.edu/papers/patzek/CRPS416-Patzek-Web.pdf>.
- Patzek, T. W., Anti, S.-M., Campos, R., Ha, K. W., Lee, J., Li, B., Padnick, J., and Yee, S.-A. 2005, Ethanol from corn: Clean renewable fuel for the future, or drain on our resources and pockets?, *Environment, Development & Sustainability* **7**: 319 – 336.
- Patzek, T. W. and Pimentel, D. 2006, Thermodynamics of energy production from biomass, *Critical Reviews in Plant Sciences* **24(5–6)**: 329–364, Available at <http://petroleum.berkeley.edu/papers/patzek/CRPS-BiomassPaper.pdf>.
- Paulsen, M. R., Mbuvi, S. W., Haken, A. E., and B. Ye, R. 2003, Extractable starch as a quality measurement of dried corn, *Applied Engineering in Agriculture* **19**: 211–217.
- Pimentel, D. 1996, *Food, Energy, and Society*, University Press of Colorado, Niwot, CO.
- Pimentel, D. 2006, Soil erosion: A food and environment threat, *Environment, Development & Sustainability* **8**: 119–137.
- Pimentel, D., Harvey, C., Resosudarmo, P., Sinclair, K., Kurtz, D., McNair, M., Crist, S., Spritz, L., Fitton, L. Saffouri, R., and Blair, R. 1995, Environmental and economic costs of soil erosion and conservation benefits, *Science* **267(24 Feb.)**: 1117 – 1123.
- Pimentel, D. and Patzek, T. W. 2005, Ethanol production using corn, switchgrass, and wood; biodiesel production using soybean and sunflower, *Natural Resource Research* **14(1)**: 67–76, Available at <http://petroleum.berkeley.edu/papers/patzek/CRPS-BiomassPaper.pdf>.
- Planck, M. 1926, *Treatise on Thermodynamics*, Dover Publications, Inc., New York, 3 edition, 1945 Dover Reproduction.
- Scavia, D., Rabalais, N. N., Turner, R. E., Justić, D., and W. J. Wiseman, J. 2003, Predicting the response of gulf of mexico hypoxia to variations in mississippi river nitrogen load, *Limnol.*



- Oceanogr.* **48(3)**: 951–956.
- Schneider, B. H. and Sprague, G. F. 1955, *Corn and Corn Improvement*, Academic Press, New York.
- Shapouri, H., Duffield, J. A., and Wang, M. 2002, *The Energy Balance of Corn Ethanol: An Update*, Agricultural Economic Report No. 814, U.S. Department of Agriculture, Economic Research Service, Office of the Chief Economist, Office of Energy Policy and New Uses, Washington, D.C..
- Shapouri, H., Duffield, J. A., and Wang, M. 2003, The energy balance of corn ethanol revisited, *Trans. ASAE* **46(4)**: 959–968.
- Shapouri, H. and McAloon, A. 2004, *The 2001 net energy balance of corn ethanol*, Report, USDA, Washington, D.C., Also presented as a conference paper by H. Shapouri, A. McAloon, and M. Wang, Corn Utilization and Technology Conference, June 7–9, 2004, Indianapolis, IN, [www.usda.gov/oce/reports/energy/index.htm](http://www.usda.gov/oce/reports/energy/index.htm).
- Sheehan, J., Camobreco, V., Duffield, J., Graboski, M., and Shapouri, H. 1998, *Life Cycle Inventory of Biodiesel and Petroleum Diesel for Use in an Urban Bus*, Final Report NREL/SR-580-24089, National Renewable Energy Laboratory, Golden, Colorado 80401, [www.nrel.gov/docs/legosti/fy98/24089.pdf](http://www.nrel.gov/docs/legosti/fy98/24089.pdf).
- Slesser, M. (ed.) 1974, *Energy Analysis Workshop on Methodology and Conventions*, The Nobel House, Stockholm, Sweden, International Federation of Institutes for Advanced Study.
- Slesser, M. (ed.) 1975, *Workshop on Energy Analysis and Economics*, Lidingö, Sweden, International Federation of Institutes for Advanced Study.
- Smil, V. 1985, *Carbon – Nitrogen – Sulfur – Human Interferences in Grand Biospheric Cycles*, Plenum Press, New York and London.
- Smil, V., Nachman, P., and Long II, T. V. 1983, *Energy Analysis and Agriculture – An Application to U.S. Corn Production*, Westview Press, Boulder, Co..
- Spiers, H. M. 1961, *Technical Data on Fuel*, The British National Committee, World Power Conference, 201 Grand Buildings, Trafalgar Square, London WC<sub>2</sub>, 6 edition.
- Spreng, D. T. 1988, *Net-Energy Analysis and the Energy Requirements of Energy Systems*, Praeger, New York.
- Stevenson, F. J. 1982, *Humus chemistry. Genesis, composition, reactions*, John Wiley & Sons, New York.
- Stodola, A. 1927, *Steam and Gas Turbines with the Supplement on the prospects of the thermal prime mover*, McGraw-Hill Book Company, Ltd., New York, 1 edition, Two volumes, authorized translation of the sixth German edition.
- Szargut, J., Morris, D. R., and Steward, F. R. 1988, *Exergy analysis of thermal and metallurgical processes*, Hemisphere Publishing Corporation, New York.
- Taiz, L. and Zeiger, E. 1998, *Plant Physiology*, Sinauer Associates, Inc., Publishers, Sunderland, Massachusetts, 2 edition.
- Tegtmeier, E. M. and Duffy, D. 2004, External costs of agricultural production in the United States, *Int. J. Agricultural Sustainability* **2(1)**: 1–20.
- Ulanowicz, R. E. and Hannon, B. M. 1987, Life and the production of entropy, *Proc. Royal Soc. London. Series B, Biological Sci.* **232(1267)**: 181–192.
- Wang, M. 2001, *Development and use of GREET 1.6 fuel-cycle model for transportation fuels and vehicle technologies*, Technical Report ANL/ESD/TM-163, Argonne National Laboratory, Center for Transportation Research, Argonne, IL 60439.
- Wang, M., Saricks, C., and Wu, M. 1997, *Fuel-cycle fossil energy use and greenhouse gas emissions of fuel ethanol produced from U.S. Midwest corn*, Report sponsored by the Illinois Department of Commerce and Community Affairs, Argonne National Laboratory, Center for Transportation

Research, Argonne, IL 60439.

White, P. J. and Johnson, L. A. (eds.) 2003, *Corn Chemistry and Technology*, American Association of Cereal Chemists.

Wright, F. B. 1994, *Distillation of alcohol and de-naturing*, Lindsay Publications, Bradley, IL, 2 edition.

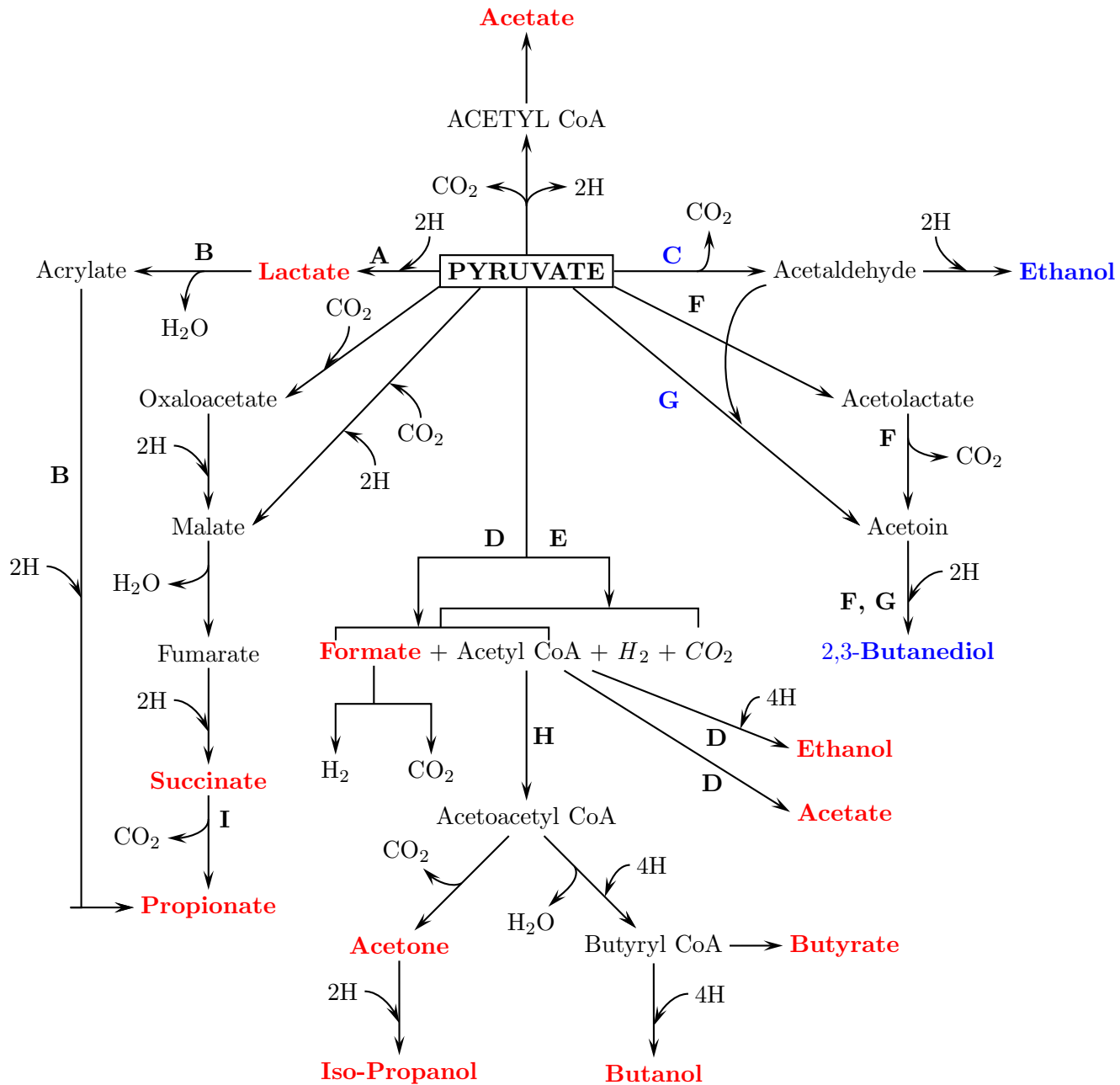

Figure 26: Pyruvate is the first stage of decomposition of glucose in beer fermentation. Only pathways C and G are activated by yeast. All other pathways are activated by aerobic and/or anaerobic bacteria. Some or most of these bacteria are present in the fermentation mash. Adapted from (Dawes and Large, 1982).

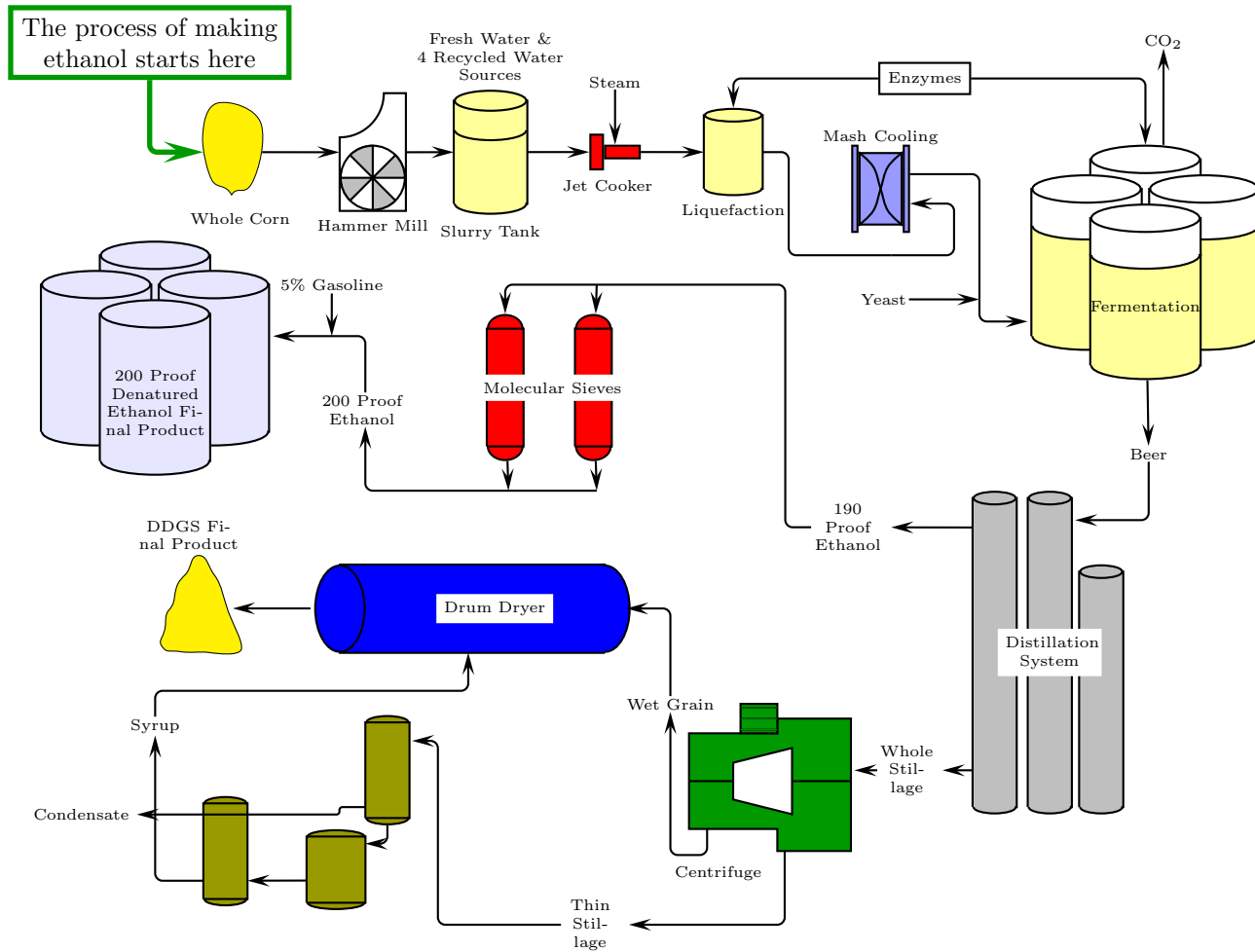

Figure 27: Schematic of a dry grind corn ethanol plant. Note that after starch hydrolysis (liquefaction) to glucose, the solid part of corn mash and oil could be physically separated from the glucose liquor, and go straight to the centrifuge and drying. Therefore, at best, the co-product energy minus the energy cost of obtaining these coproducts, could be subtracted from the input grain energy.